

DESIGN BOOKLET

GUIDELINES FOR PROFESSIONAL HOUSE BUILDERS AND ASSOCIATED PARTNERS:
ARCHITECTS, ENGINEERS & INSTALLERS

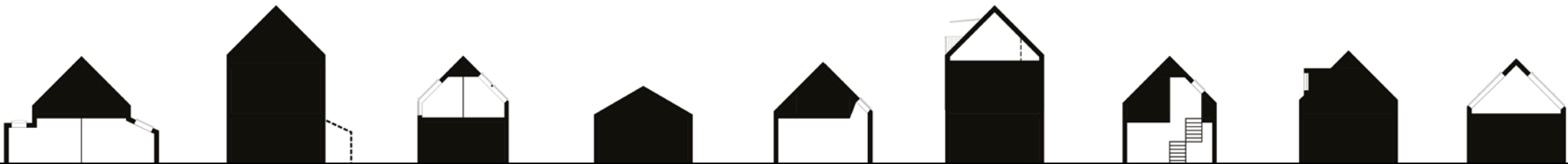

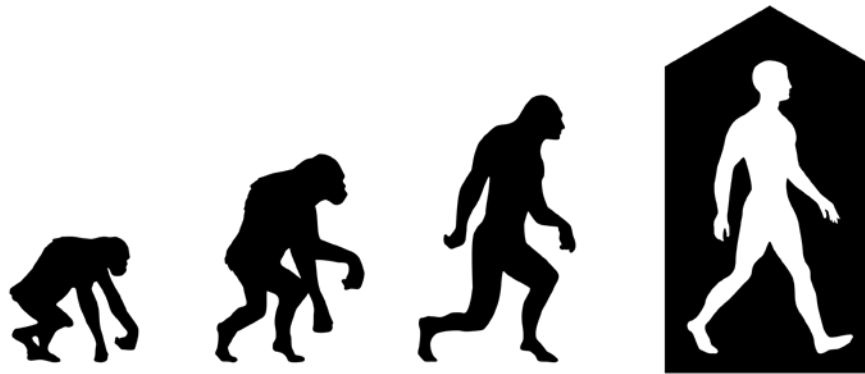

SOLUTIONS FOR THE INDOOR GENERATION

Contents

I	2	Space Type Selection
II	6	Space Type Solutions
III	140	Lining Details
IV	148	Measuring Daylight
V	152	Space Design Tips for Attic Levels

1

The space type that requires inspiration for improved daylight and ventilation conditions is....

• On a ground or intermediate floor

01

pg. 8

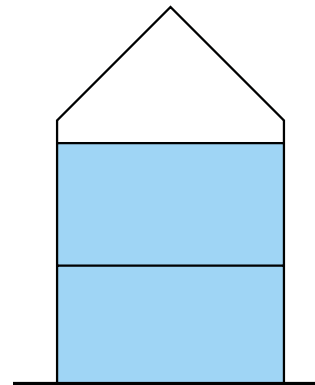

• Below a flat roof structure

02

pg. 45

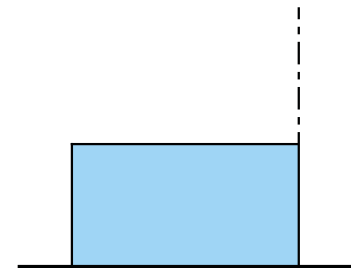

Below a non-habitable, pitched roof (flat ceiling)

03

pg. 57

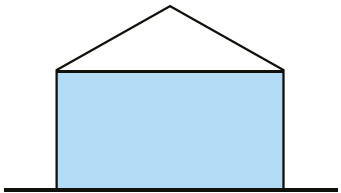

An open space with sloped ceiling

04

pg. 71

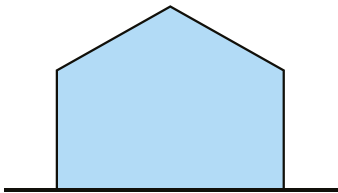

A mezzanine space

05

pg. 85

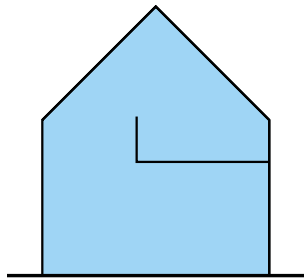

An attic space

06

pg. 95

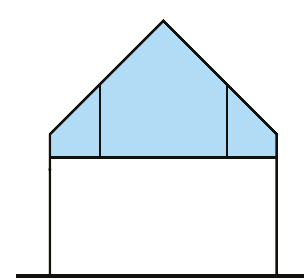

An attic space with a dormer

07

pg. 129

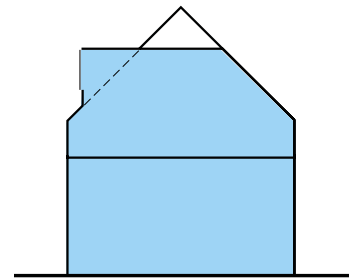

||

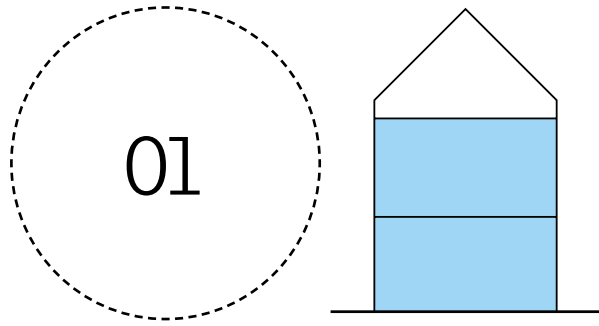

A GROUND OR INTERMEDIATE FLOOR

There are 3 key strategies to improve daylight and indoor air quality on the ground and intermediate levels of your project.

POSSIBLE SOLUTIONS

A

Ground Level Extension

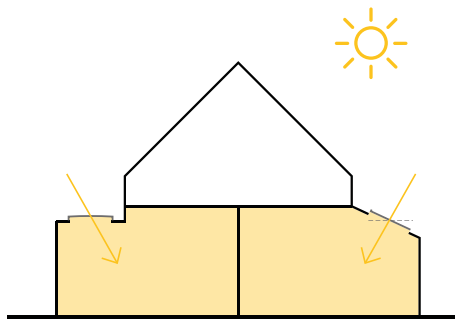
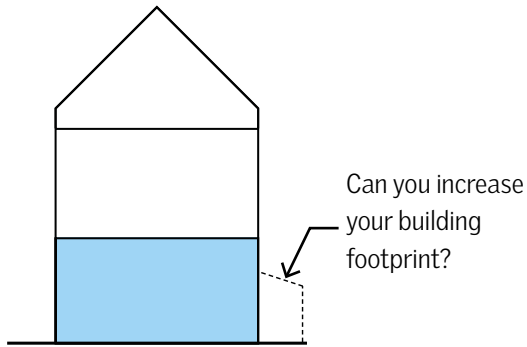

Electric Operated Roof Windows

B

Stairwell as Lightwell

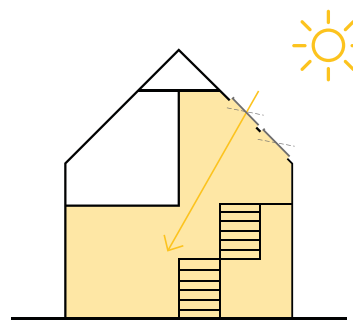
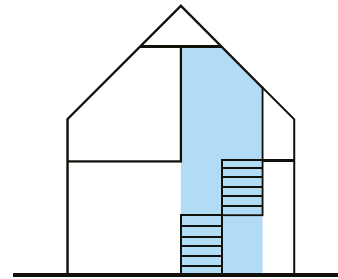

Electric Operated Roof Windows

C

Light Shaft in Unused Roof Space Above

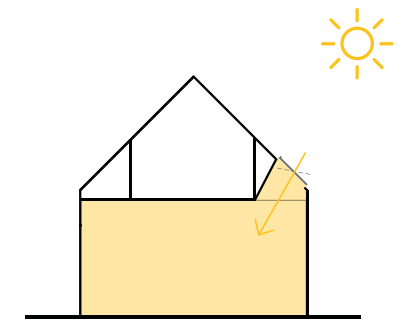
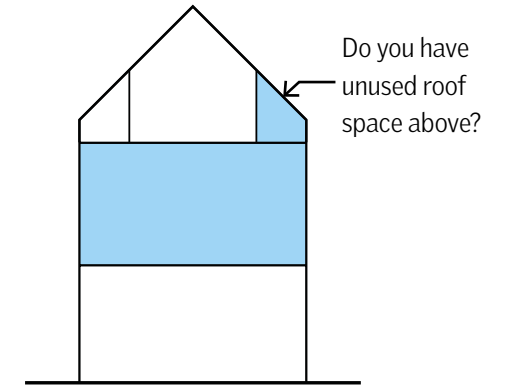

Electric Operated Roof Windows



SPACE TYPE

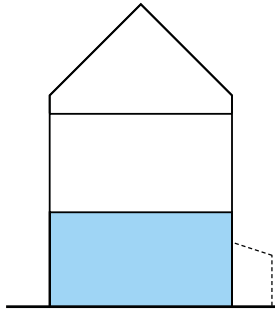
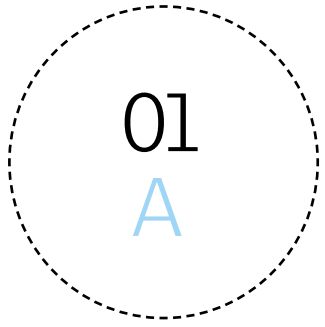

A GROUND LEVEL
EXTENSION



Is daylight and fresh air part of what makes your product better value than others?

Optimal daylighting and indoor air quality will differentiate you from your competitors, increase your profit margin and speed up sales. Customers easily see the 'wow' factor & feel the comfort, automatically placing higher value in these spaces.



AFTER

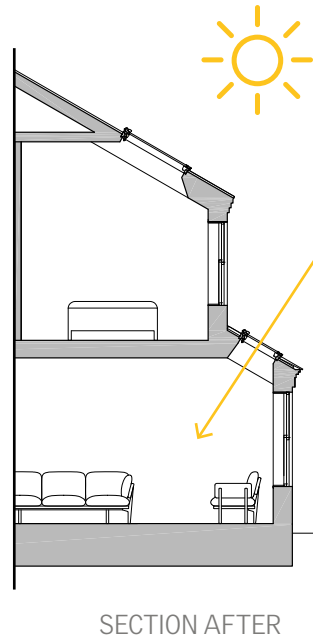

Is your ground level plan restricting possible daylight?

You add value to your project with an extension incorporating roof windows by:

- directing light deeper into rooms
- providing up to two times more daylight than equally sized facade windows
- giving an opportunity for privacy whilst maintaining access to daylight
- increasing the feeling of spaciousness through added volume and light



AFTER

Cooking is one of the most significant activities affecting air quality in any home

Cooking creates a significant amount of humidity and airborne particles and even with mechanical rangehoods the effect is not typically dealt with adequately. The resulting poor air quality becomes a major factor in the occupants likelihood of developing illnesses such as asthma and allergies.

High level, operable windows in kitchen spaces deal with this polluted air well, by allowing it to escape quickly without creating uncomfortable drafts for the occupants.

Indoor air quality can be measured easily with a range of tools now available on the market. Many customers, once made aware of the health impacts of poor air quality, take a strong interest and investment in ensuring their home is healthy to live in.





AFTER







Improve indoor comfort from both sides

Energy efficiency is gained not only through a decreased reliance on electric lighting but through solar heat gain in winter and ventilative cooling in summer.

Blinds and shutters are the perfect tools to control incoming and outgoing light and temperature. By combining an interior product for light adjustment or heat loss reduction with an exterior awning or shutter for heat protection, it's easy to get just the right degree of control for optimal indoor climate and preferences.

Exterior awning blinds reduce passive heating by blocking the sun's rays before they reach the window. They keep the heat outside, maintaining a cool, comfortable temperature inside. The fabric is transparent, preserving the view and letting in light.

Interior blackout blinds give complete control over the light, delivering 99.9% blackout for a great night's sleep or refreshing nap during the day.





SPACE TYPE

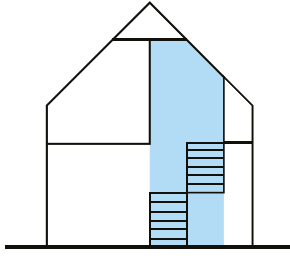
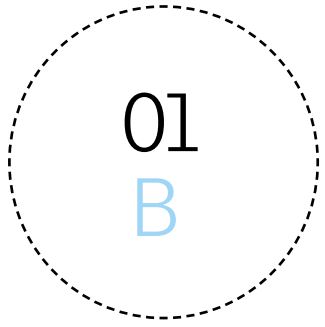

STAIRWELL AS
LIGHTWELL

By adding roof windows over a stair you add value to your project

Value is added through:

- Creation of stack effect ventilation, where connecting rooms can effectively utilise this space as a 'chimney' to exhaust warm, stale and humid air
- Providing safe way-finding on stairs without the need for electric lighting
- Adding 'wow' effect, by distributing daylight to every floor, often this can include a direct view to the sky from entry halls or from the centre of the home
- Bringing daylight into centre of the floor plan typically starved of light

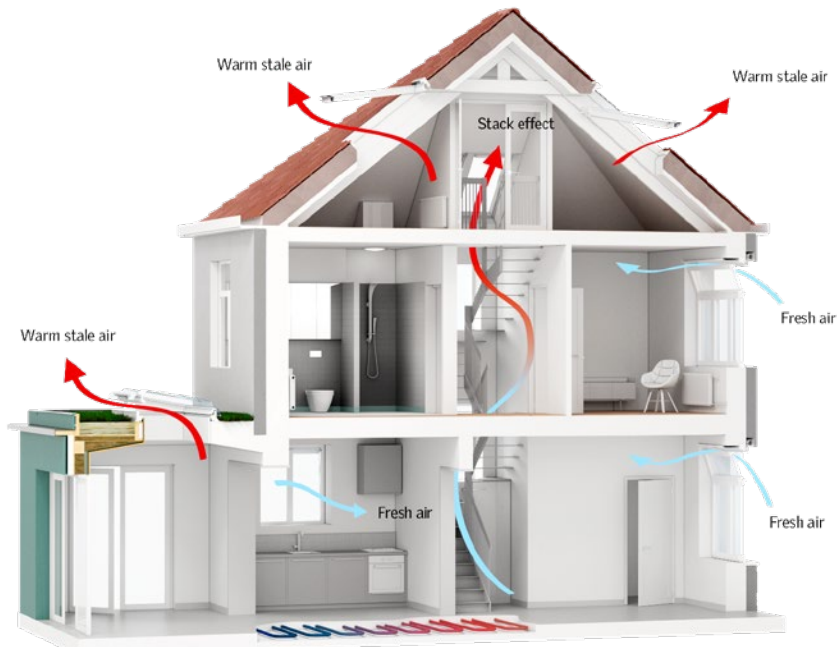



First impressions last!

How bright is your project's entry hall? Do your customers walk into a small, dark entry room or are they hit with 'wow factor' and daylight?

It is often possible to incorporate roof windows on the back facade with a light shaft directed right to the entry door. If you or your local planning department are concerned about roof windows from the street, consider a design solution that directs daylight from back to front.

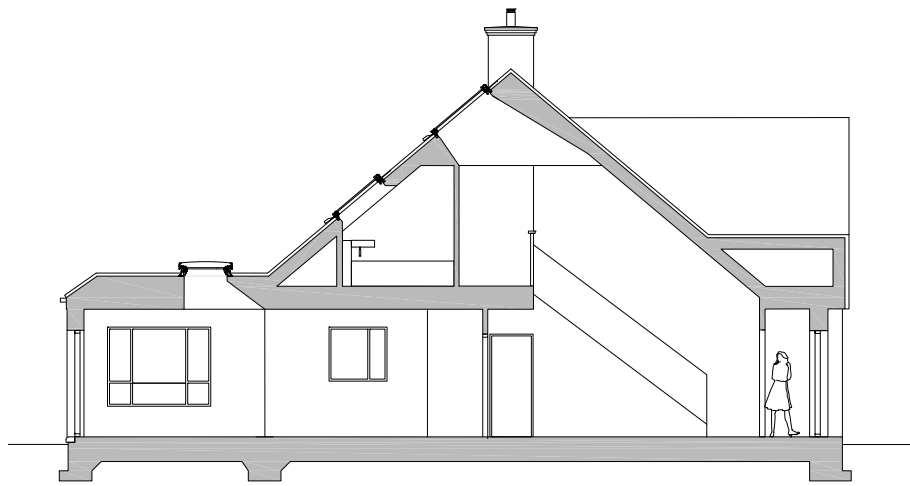

SECTION AFTER

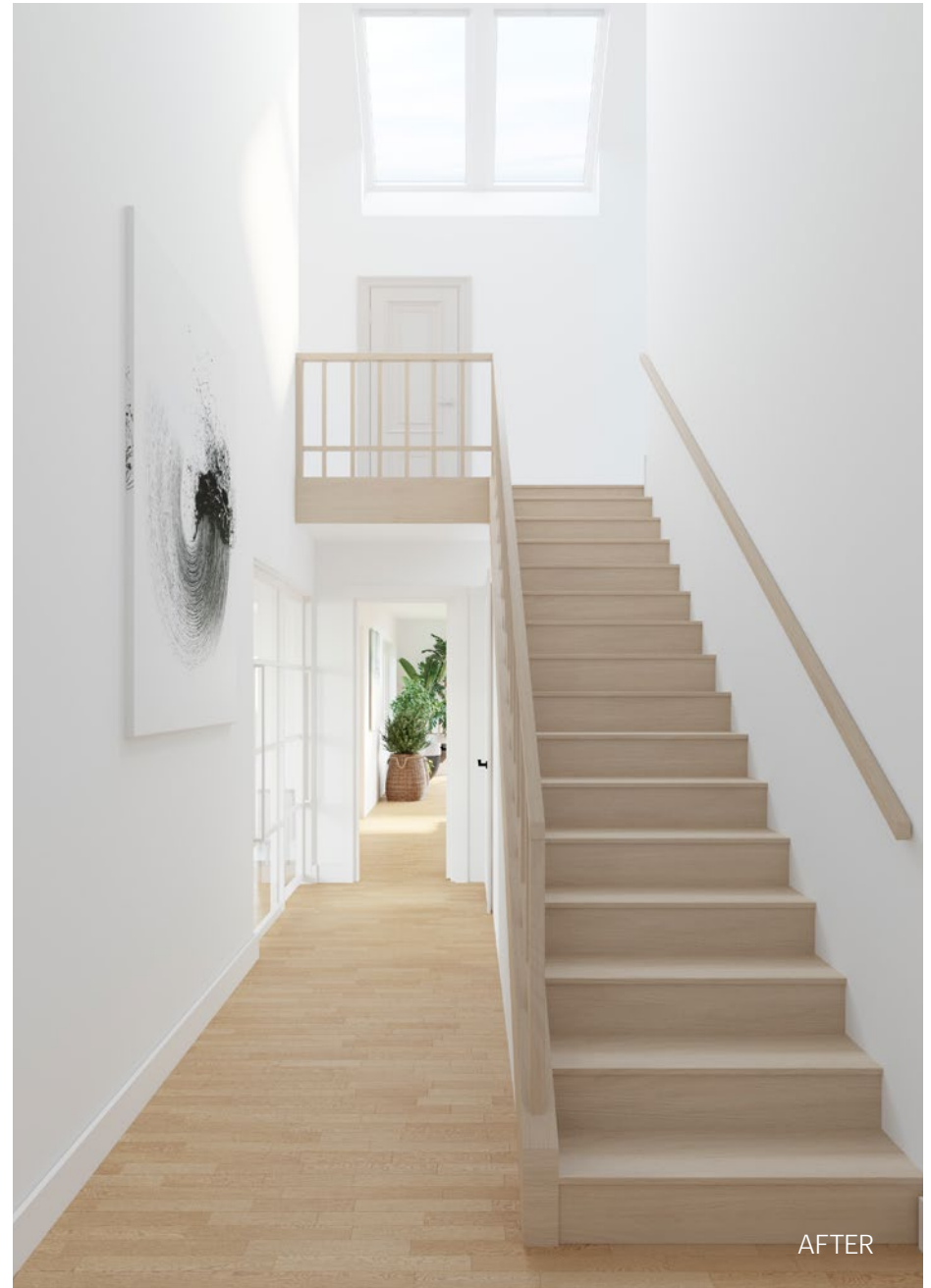

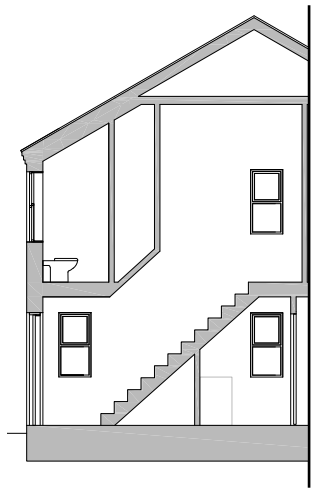

SECTION BEFORE

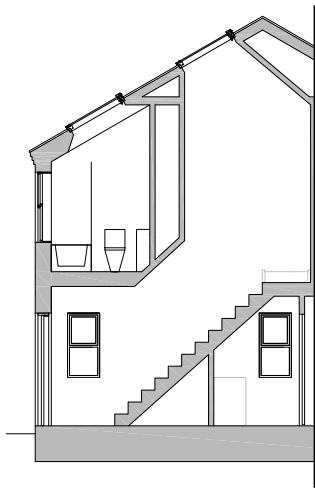

SECTION AFTER





Is there always value in traditional facade windows?

On tight sites that aim to maximise potential sales area, there are often times when facade windows introduce issues of privacy without giving benefits of views, daylight or ventilation.

Consider replacing these with roof windows for increased value.

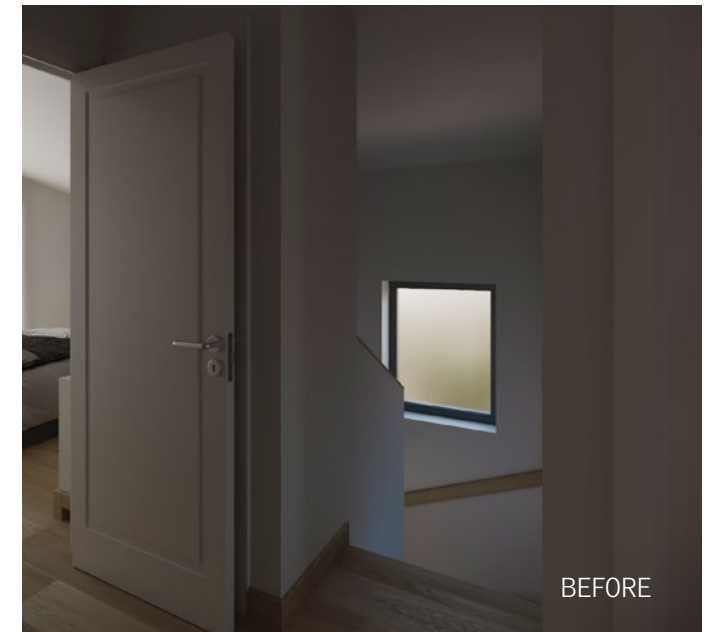



AFTER

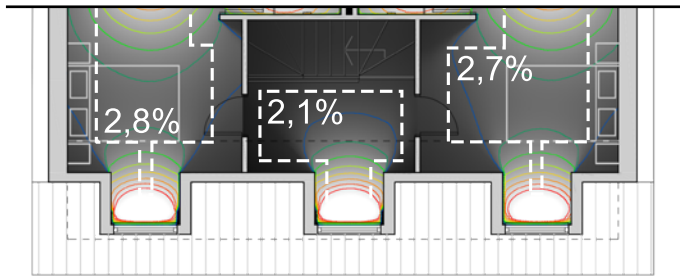
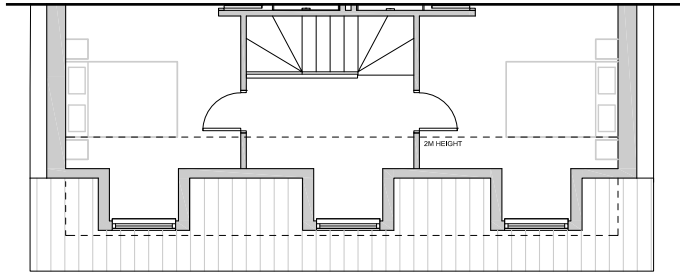

FLOOR PLAN & DAYLIGHT ANALYSIS BEFORE

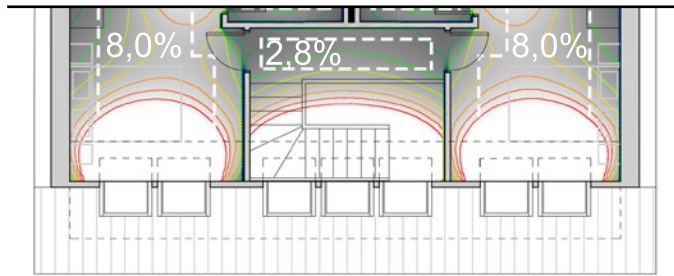
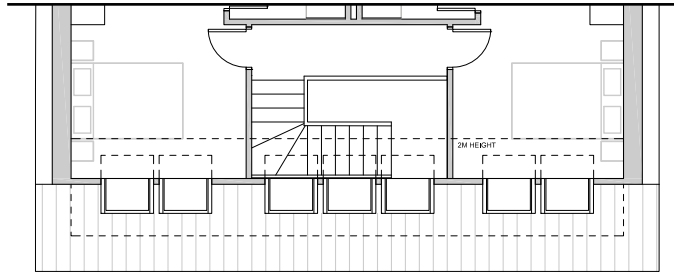

FLOOR PLAN & DAYLIGHT ANALYSIS AFTER

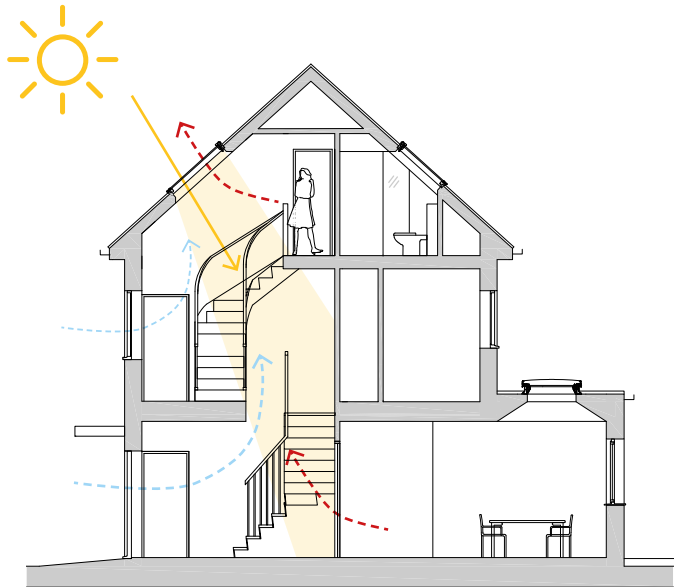
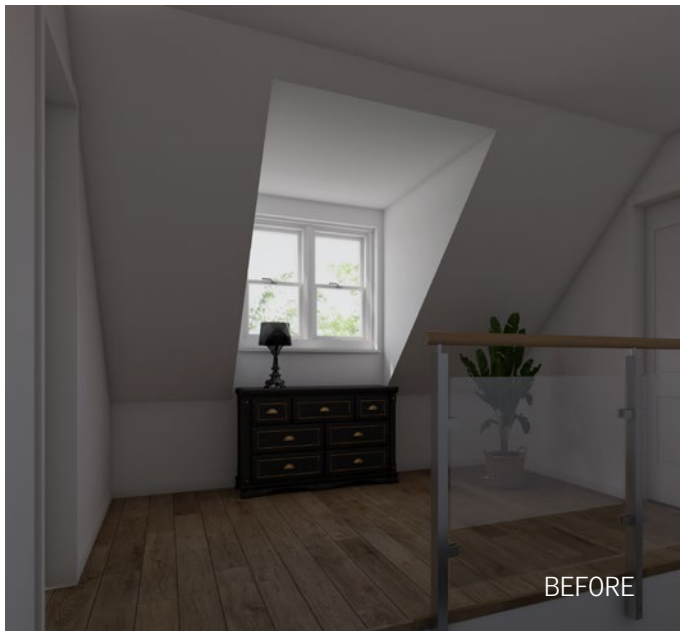

SECTION AFTER

Tips for designing with stair wells as light wells

- Consider opening the stairwell up to adjacent spaces (open plan lower levels) to allow full benefits of the light & ventilation - check your local fire regulations.
- If stacking more than one stair run, consider designing in a small void that allows daylight from above to continue to the lowest floor.
- Make use of low head height space by placing the stair climb below the roof slope & adding roof windows for 'wow' effect.

*Refer p.150 for more information on Daylight Analysis.



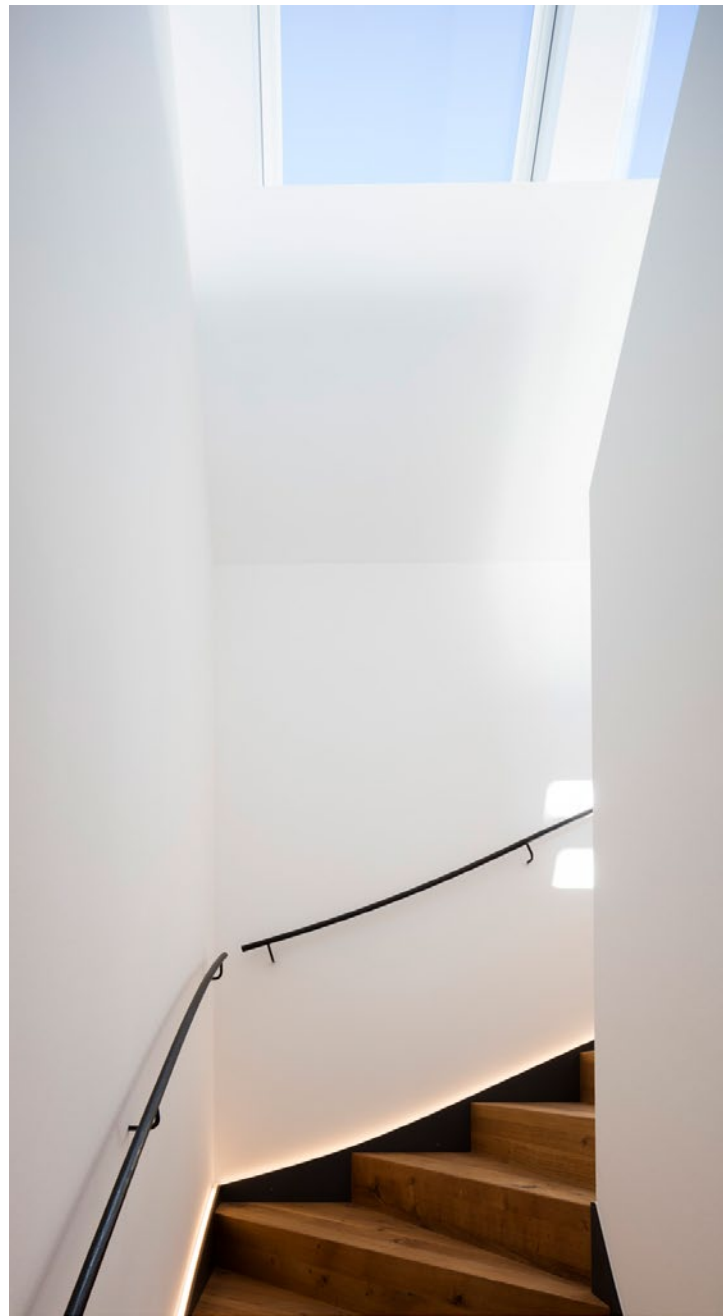



SPACE TYPE

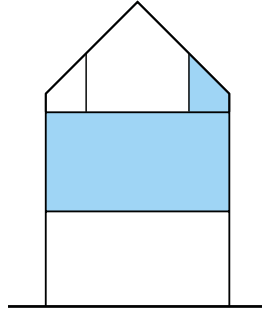
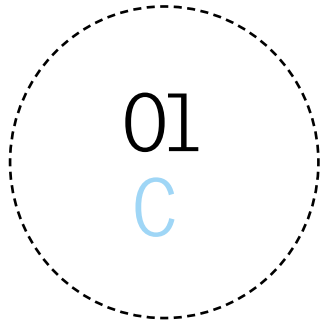

A LIGHT SHAFT USING
ROOF SPACE OVER

Daylight has a real value

In France 1 out of 2 home buyers see little to no difference between the proposals of professional home builders.* To stand out from your competitors, daylight from above is a serious proposal to consider enhancing your offer. A recent market study conducted in Belgium shows that 86% of buyers preferred the home designed with better daylight conditions.

It can often be difficult to bring light into the mid-levels of a multi-story home whilst maximizing functional space within the layout. Light shafts utilising unused roof space above are a great way to add value to these ordinarily, dark spaces.

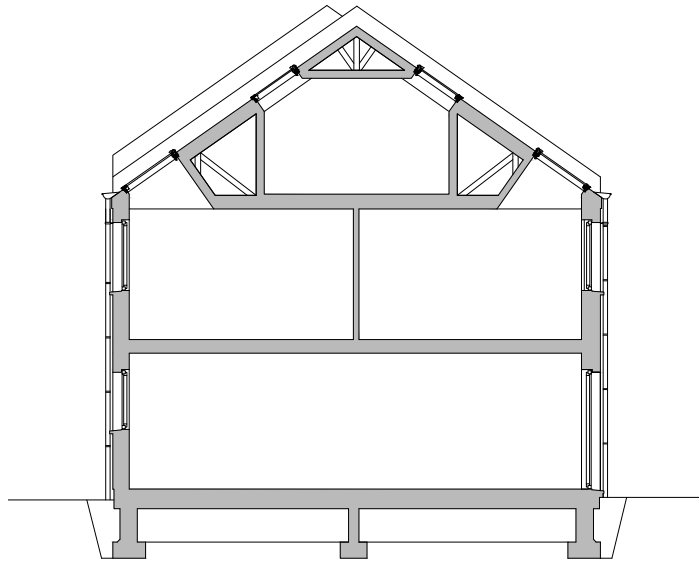

SECTION AFTER

*source: BVA (Sep. 2018) – 544 online interviews of second time home buyers.





AFTER



BEFORE

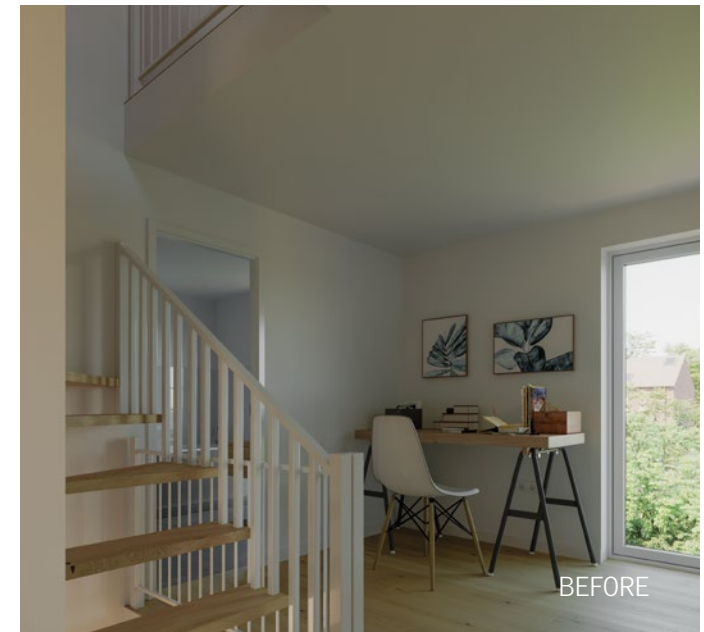

BEFORE



The most important spaces for the future

Study spaces and kids' bedrooms are often in the darkest, least ventilated area of a house - the mid-level. Several studies found that daylight can improve how quickly children learn and retain information by up to 18% and productivity has been shown to improve by up to 15%*.

Daylight is one of the greatest tools when it comes to helping improve the lives of your customers, their families, their health and the future of their children. Improving the quality and amount of daylight exposure throughout the day can make a significant difference to people's lives.

*Source: Barrett, Zhang, Davies, and Barrett (2015) - Clever classrooms: Summary report of the HEAD project.



BEFORE



AFTER

Playful design features

Consider the angle of the knee walls to the room in the attic space - is it a rumpus space where angled walls could become a feature for a relaxed seating design whilst at the same time creating an optimal light shaft to the room below?

*Refer p.150 for more information on Daylight Analysis.

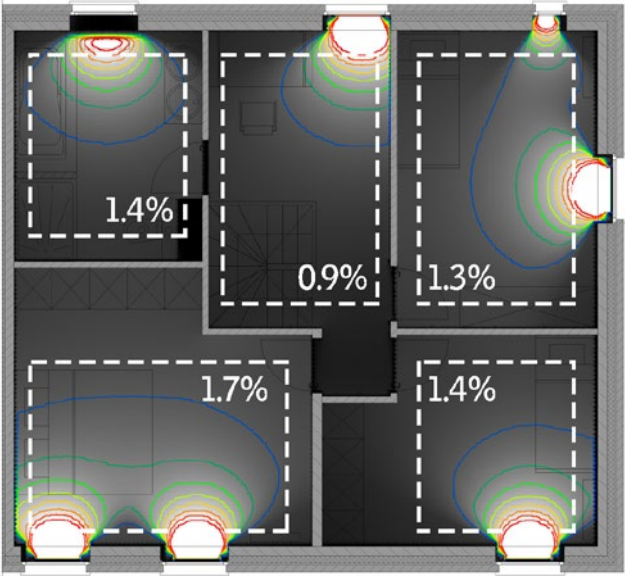

DAYLIGHT ANALYSIS BEFORE

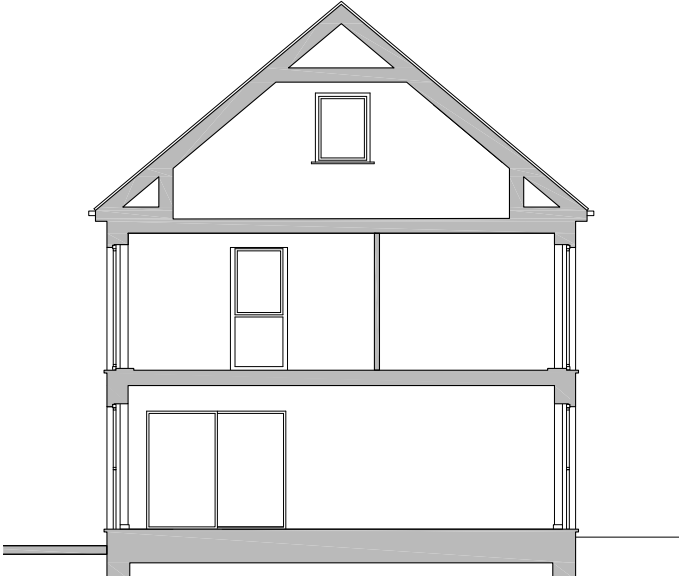

SECTION BEFORE

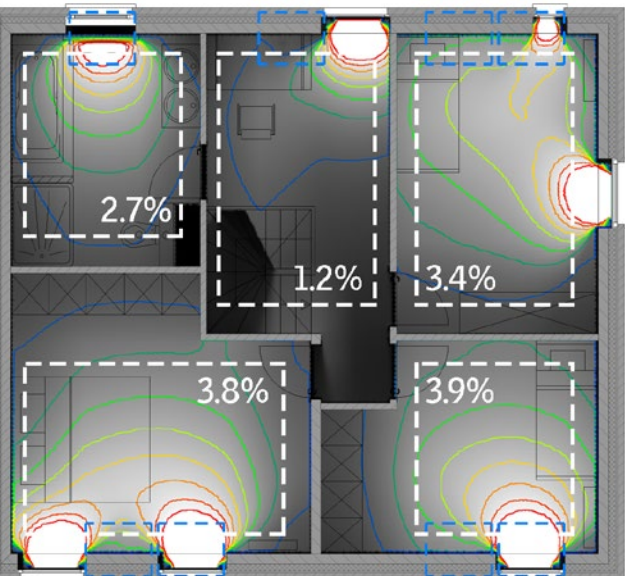

DAYLIGHT ANALYSIS AFTER

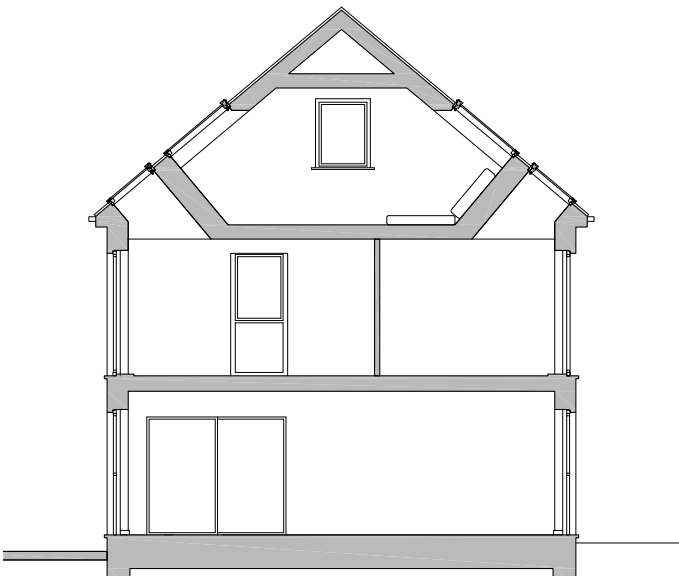

SECTION AFTER

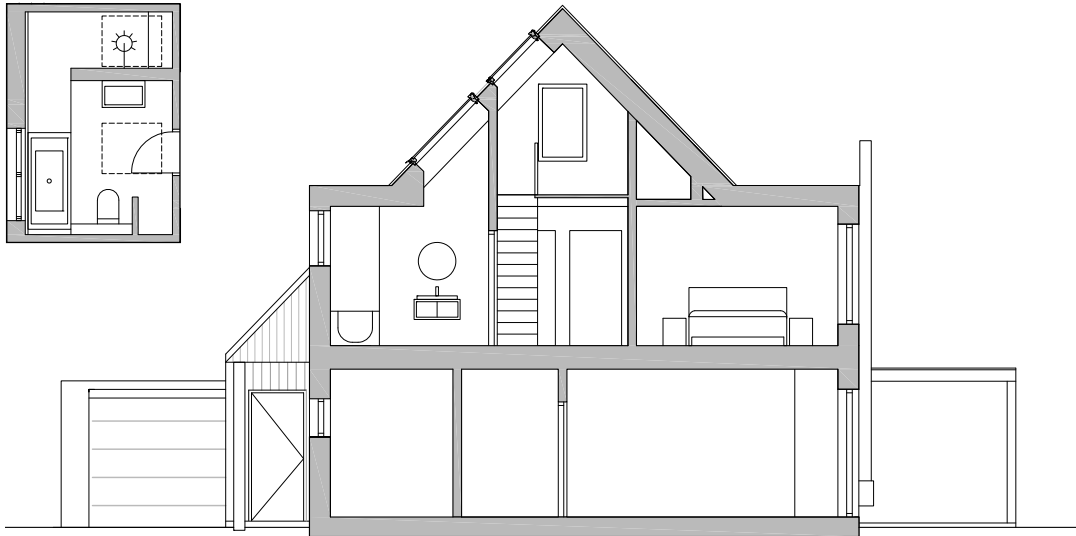

FLOOR PLAN AND SECTION

Potential to balance daylight and create a feeling of generosity

In some cases the light shaft can be placed to balance light to the 'internal' side of a room that would otherwise be starved for light. This not only reduces the effect of glare but makes the room feel much larger due to the generosity in the high volume.





SPACE TYPE

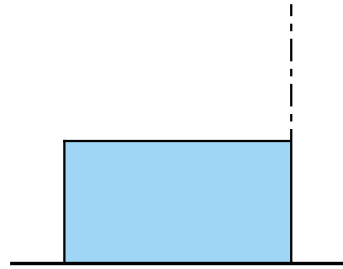
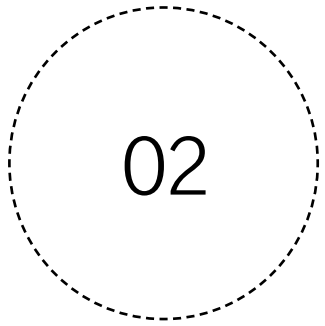

Below a flat
roof structure

POSSIBLE
SOLUTIONS

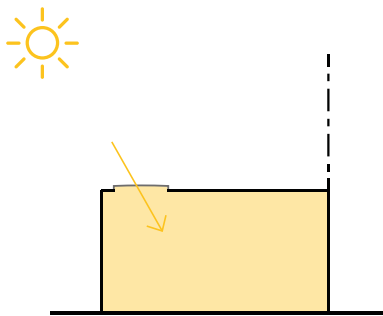

Electric Operated
Flat Roof Windows

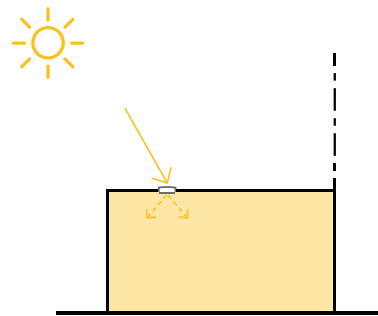

Sun Tunnel



Are there utility spaces in the home that, by introducing daylight, can become a real entertainment area for some customers?

Some customers are willing to pay extra to have not just a garage, but a 'workshop' - a space that doesn't just feel like a storage corner but a room to utilise.

This can increase the value of m² area without creating a need to increase the building footprint. Daylight & ventilation in these spaces bring large comfort and health benefits as well as the perception of a generous space.

Does your design include a basement with limited natural light? Consider extending the footprint to allow flat roof windows to be installed above - completely transforming the space.





Quality daylight in a bathroom lifts the space to luxury

Single-story buildings with flat roofs and deep rooms often struggle to bring natural light into every corner. Most often, bathrooms and wardrobes will be placed in the middle of the plan. Natural ventilation and good daylight are crucial to these humid or prone to humidity spaces.

A roof opening will distribute more daylight into central rooms and other darkened areas. Installing a simple roof window can cost less than some kitchen appliances – and yet the daylight and ventilation it provides can brighten up and transform a space, improve thermal comfort, save energy, and even improve health and well-being over the long term.

Home buyers are willing to pay extra for daylight or make some trade-offs for getting better daylight. A market study conducted in Germany shows that 3 out of 4 potential customers would pay double the price of the roof window for the gain in daylight in the bathroom.



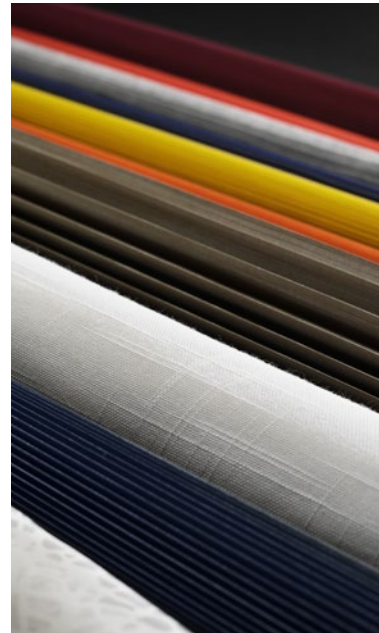

True colours

Daylight is the ideal source of illumination for good colour rendering and it enables us to distinguish slight shades of colour.

In daylight, the colours of objects around us obviously look natural. That is one important reason, for many home owners, to have good daylight in bathrooms or in spaces where precision and a good combination of colours are important.



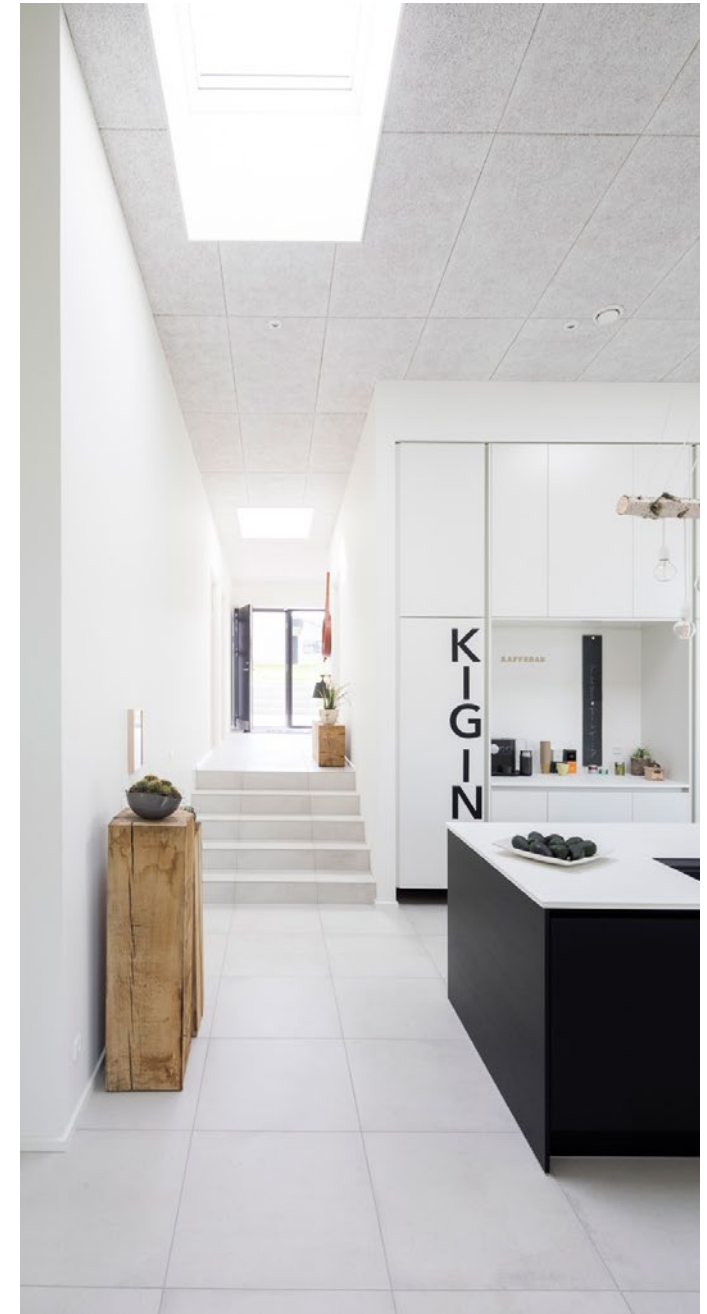



The value in modern aesthetics

When they are given the possibility, home buyers will choose homes with spaces that are brighter, more modern, less ordinary. Daylight solutions are characterised as attractive, smart and adding value to the house.

Homes with roof windows in Denmark are sold for €15,630 more than equivalent homes without roof windows.*

*Source: Boligsiden Study (2018)



BEFORE



AFTER



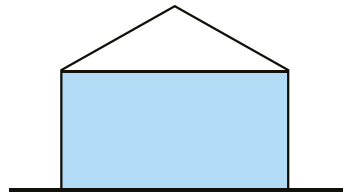
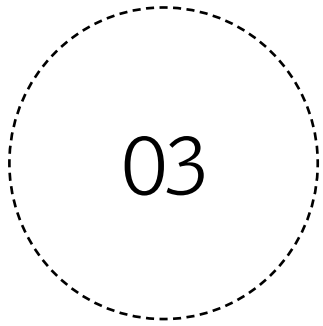

Below a non-habitable,
pitched roof (flat
ceiling)

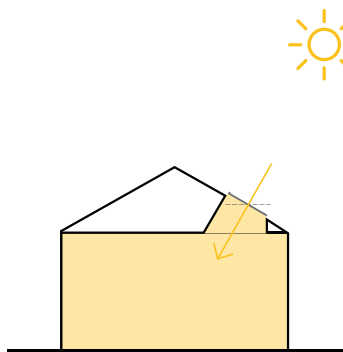

Electric operated roof
windows

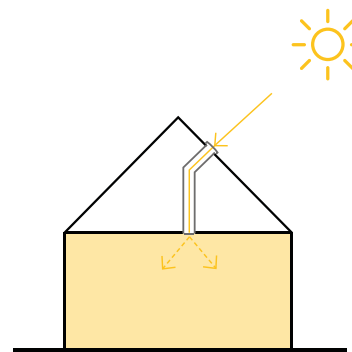

Sun Tunnels

Create value for your customer by minimising the running costs of their new home

The daylight and ventilation that roof windows provide will not only brighten up and transform a space, it will also improve thermal comfort, save energy, and even improve health and well-being over the long term.

Most people turn on electrical lighting at home, in the morning or after work, when it is too dark inside to properly function. Plenty of daylight will eliminate the need for artificial lighting during the day and reduce the electricity bills.

Home buyers prefer better daylight conditions and will choose it, when given the opportunity.





AFTER

Optimize your return on investment

Building light shafts in truss roof systems is a straightforward process. To maximize the return of investment, in many cases, it is beneficial to choose horizontal combinations of 2 or 3 roof windows in one shaft. You will create an optimal interior daylight level and create a 'wow' effect for your customers.

If the space calls for only one window, it is optimal to use wider, shorter sizes and position them close to the exterior wall line. This will achieve a more shallow light shaft and maximise the daylight introduced.





AFTER





Children's rooms are often the most polluted

Children's bedrooms are often located on mid or upper levels starved of light and cross ventilation. Often kids' rooms are the worst places to be for air pollution. As well as toxic particles from sources around the home, the many toys and electronic appliances found in most children's rooms can also be responsible for potentially harmful emissions.

Air pollution and high CO2 levels can lead to problems like headaches, troubled sleep and fatigue through to difficulty concentrating. Poor indoor climate can be particularly hard on children because they are still growing, and they breathe faster than adults.

Natural daylight and ventilation are important factors in achieving a good indoor climate. Offer your customers healthy homes that keep them and their families healthy.

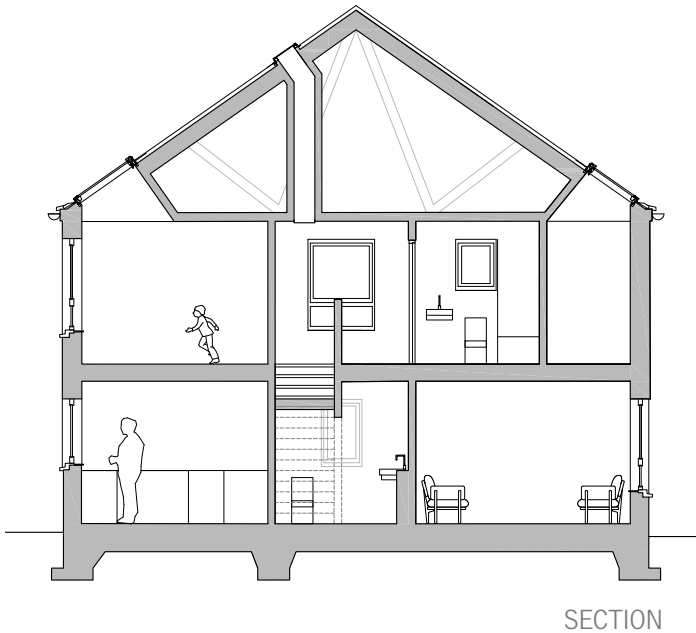



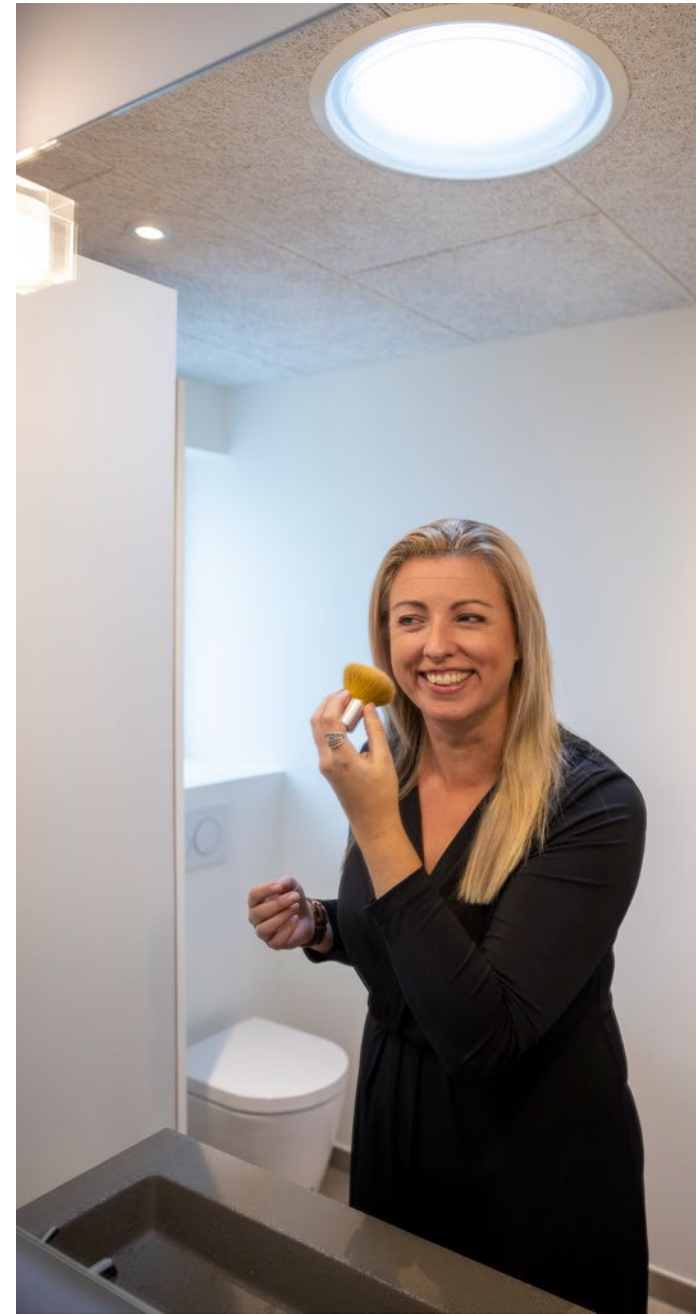



Choosing the right solution for the context

Shallow light shafts, deep light shafts or sun tunnel? Choose the daylight solution that best fits your design and brings most value to the interior space.

- Sun tunnels are great for smaller utility spaces located deep in the floor plan.
- Shallow light shafts are great for rooms that you may wish to offset privacy issues created by facade windows to the street or to balance the daylight and ventilation within the space.
- Deep light shafts create a dramatic effect and can be a great feature above stairs or in a living space. It is optimal to include more than one roof window in a deep shaft.

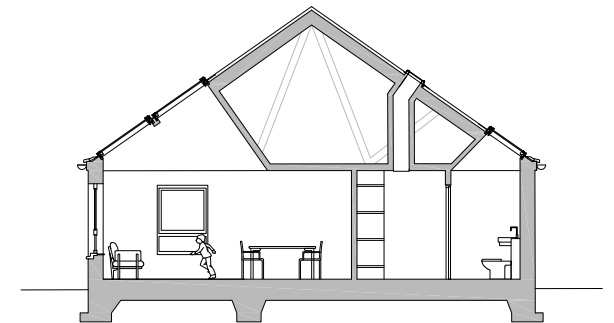



The construction is simple

Whether cutting a truss or leaving the structure exposed within a wider light shaft, there is a simple construction solution that allows an optimal daylight shaft to be integrated into your home design.

If the daylight shaft is planned from the beginning, the truss engineering can be designed and co-ordinated to reduce the number of on-site cuts required.





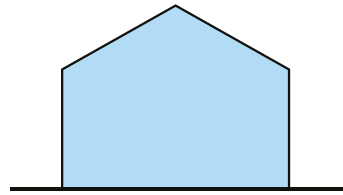
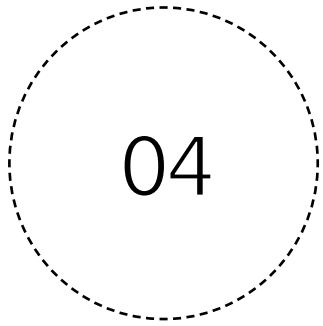

An open space
with sloped
ceiling

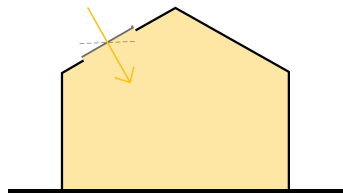

Electric operated roof
windows

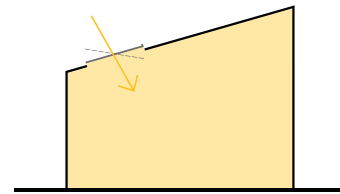

Electric operated roof
windows

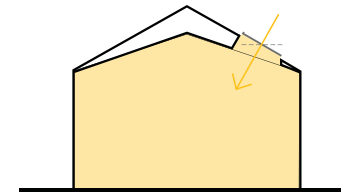

Electric operated roof
windows



Balanced daylight increases comfort

Consider the position of roof windows on both sides of a room to achieve better distribution of daylight and reduce possible effects of glare.

Roof windows have been shown to provide greater wall luminance compared to dormer and façade windows, resulting in less glare due to a softer transition between pane and wall.





It's easy when you know how

A daylight solution is not just about the amount of light you have coming in. It's also about balancing the daylight right, making the most of views, maximizing the sense of space and creating a room that looks great, feels great and works just the way it should.

When you get the daylight right, the room feels bigger, the space feels brighter and your customers feel better.



AFTER





Looking outside changes the inside

When the interior is open to the sky and surrounding landscape, the perception of the room is altered entirely – suddenly becoming a doorway to the outside, a place with plenty of daylight, space and a connection to nature.

A wide array of studies underline the effects of maintaining a visual link to the outdoors*. A view with layers of sky, city or landscape, and ground could counteract tiring monotony and help relieve the feeling of being closed in.

Home buyers see the value and choose houses designed with better outdoor communication.

*Source: Boyce, Hunter, and Howlett (2003) - The Benefits of Daylight through Windows

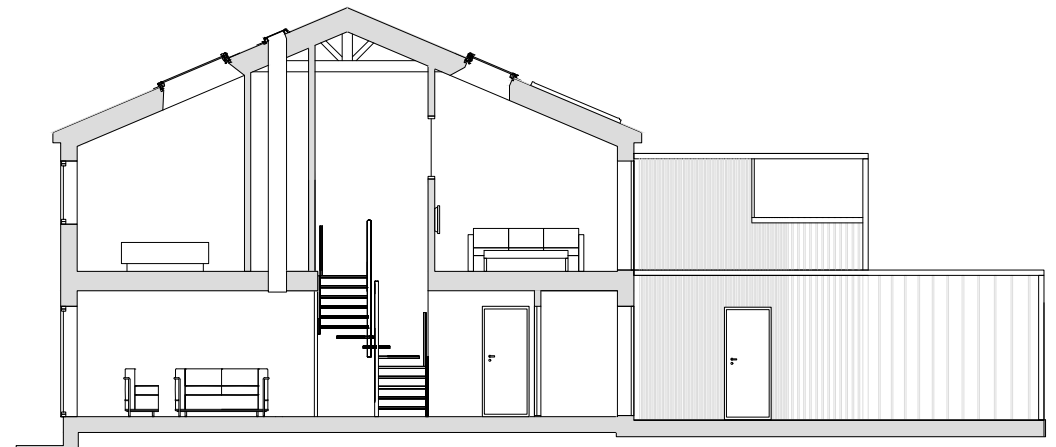

SECTION



BEFORE

Higher daylight levels can improve how quickly children learn and retain information by up to 18%*. If your customers have children who will be studying in the home, they will be interested to hear this.

*Source: Barrett, Zhang, Davies, and Barrett (2015) - Clever classrooms: Summary report of the HEAD project.



AFTER

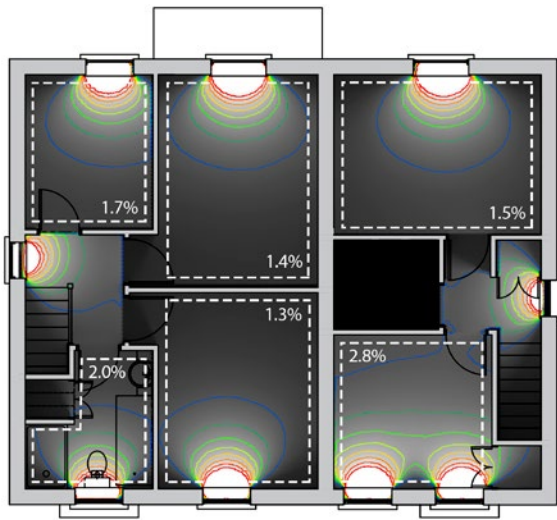

DAYLIGHT ANALYSIS BEFORE

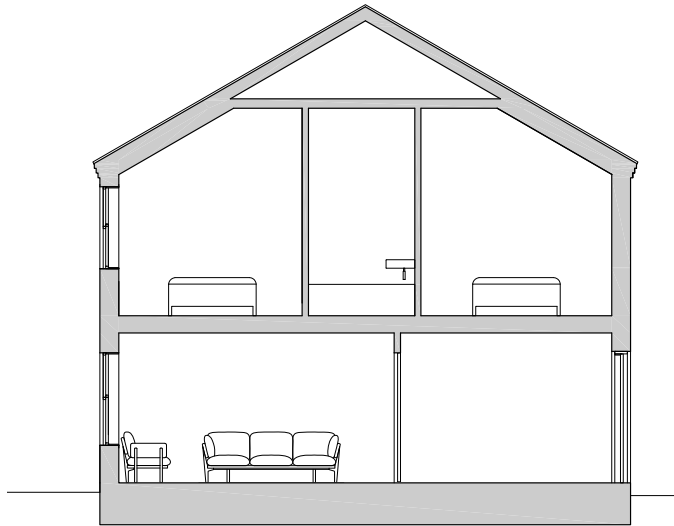

SECTION BEFORE

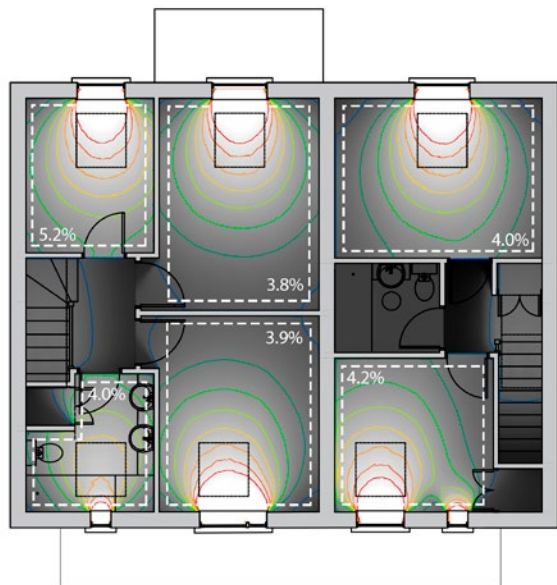

DAYLIGHT ANALYSIS AFTER

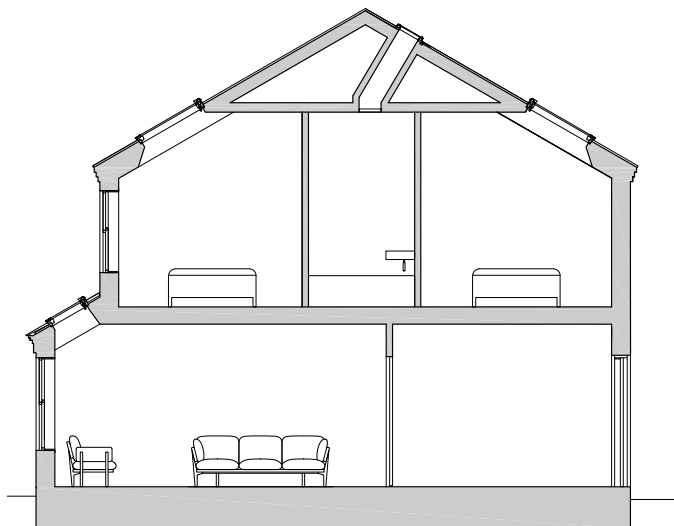

SECTION AFTER

The benefits are also in the unseen - let your customer know!

Daylight is one of the greatest tools a home builder has when it comes to helping improve the lives of their customers, their families, their health and the future of their children. Who are your customers and what is important to them?

There are studies that show higher daylight levels can help with pain relief and recovery by up to 21%.* This can be a huge improvement to the well-being of many home owners but it is particularly relevant for an aging population.

*Source: Walch, Rabin, Day, Williams, Choi, and Kang (2005) - The effect of sunlight on postoperative analgesic medication usage.

*Refer p.150 for more information on Daylight Analysis.

Free up space whilst increasing privacy, daylight and natural ventilation

In many cases, façade windows will not provide enough daylight to the interior spaces. Sometimes this is because of the neighbouring buildings, having obscure glazing, or simply because the room is a few meters deep and the daylight cannot reach so far.

Roof windows are an excellent source of natural light. They can let in more than two times as much light as vertical façade windows of the same size, and three times more than vertical dormer windows. Roof windows distribute light evenly, saving energy and improving your visual comfort levels.











SPACE TYPE

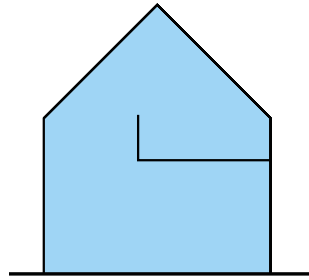
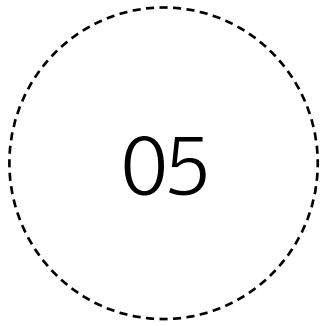

A mezzanine space

POSSIBLE SOLUTIONS

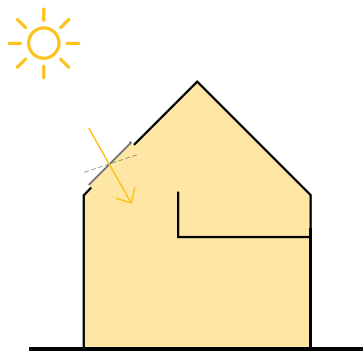

Electric operated roof windows

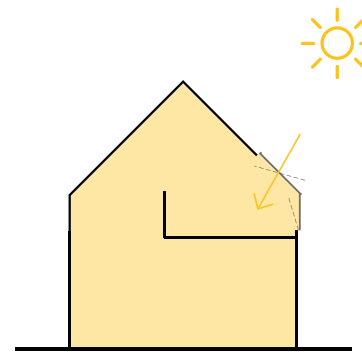

Operable roof windows with optional vertical element



Double the effect

By placing windows opposite the mezzanine floor, you allow light to spill into the lower and upper space.

Plenty of daylight will eliminate the need for artificial lighting during the day and make interior spaces more appealing to home buyers.

At the same time, the possibility of opening the high placed windows enables efficient ventilation through stack effect.





Indoor air has been shown to be up to 5x more polluted than outdoor air*

Ventilation is a balance between energy consumption, health and costs – too much ventilation will increase energy use in cold climates and lead to draughts, too little will cause bad indoor air quality and possible health problems.

The best way to achieve a good balance is through active systems that use smart sensors and automatically open and close windows, to ensure optimal indoor climate with low energy consumption.

*Source: World Health Organization (2018) - Ambient air quality and health.







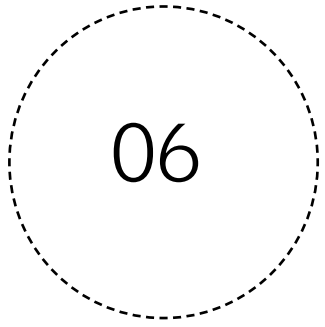

AN ATTIC SPACE

To determine the optimal daylighting solution for your attic space the height of [parapet](#) wall should be considered:

A

High 'Parapet' wall

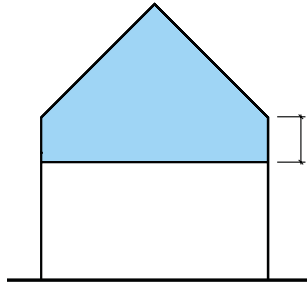

B

Low/No 'Parapet' wall

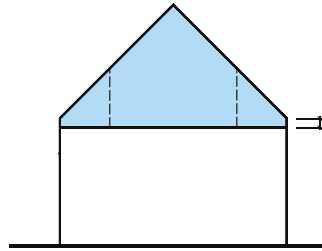

POSSIBLE SOLUTIONS

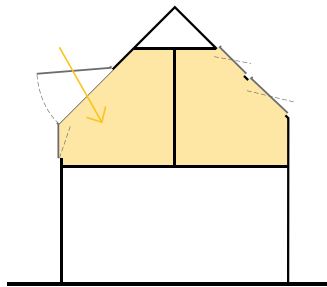

Vertical/Combination Roof Windows

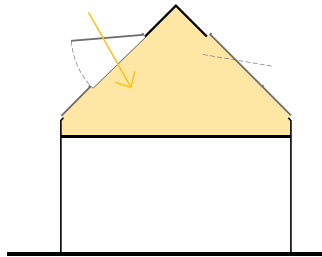

Combination Fixed/Operable Roof Windows

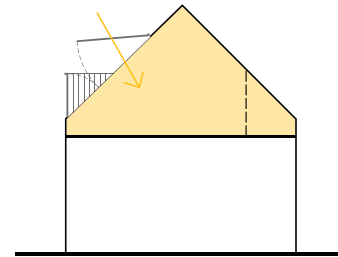

Balcony Roof Windows

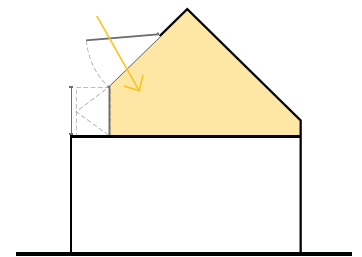

Vertical Hinged/Combination Roof Windows



SPACE TYPE

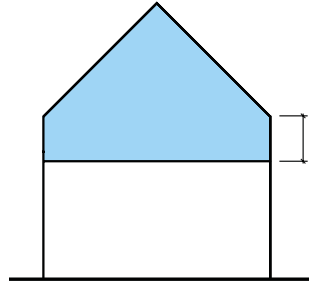
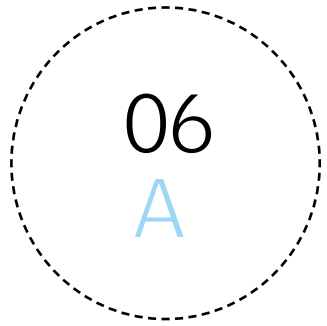

AN ATTIC SPACE WITH
HIGH PARAPET WALL



Spectacular 180° views

To stand out from your competitors, offer your customers modern, unique designs.

The top floor has the advantage of always having the best view.

Use roof windows to create a balcony-like feeling that fills the space with natural daylight.

The slope of your roof and size of the window will determine the optimal installation height. For top hung windows it is optimal to use the base of the window as a 'balustrade'. Always check your local regulations for any fall prevention requirements.



Up and out - Expand your view

A combination of vertical and sloping windows expand views and increase daylight.

This is a perfect combination for one and a half story properties with high parapet walls or with upper levels that have particularly special views.

It can also be an optimal solution for childrens bedrooms on attic floors as it allows views and light at a lower level.

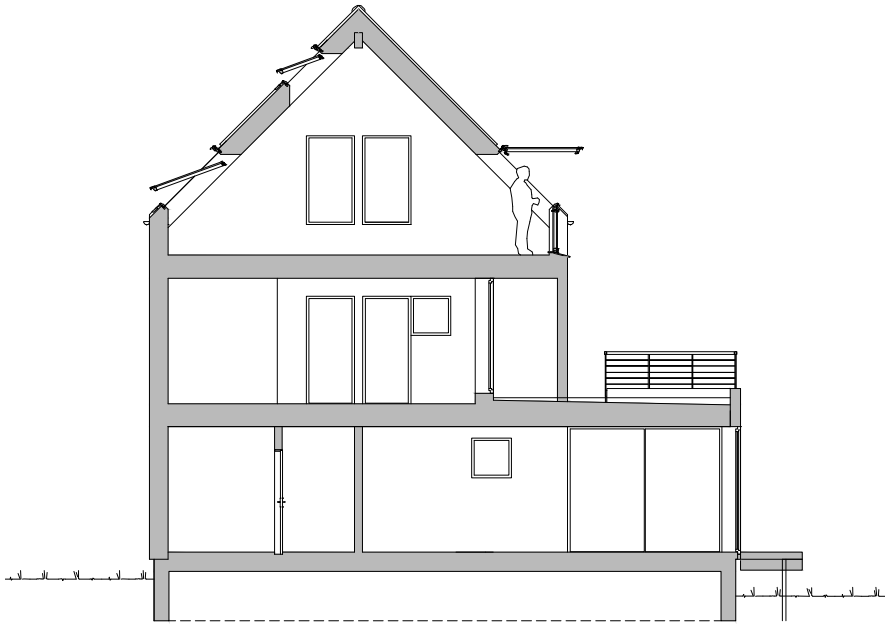

SECTION



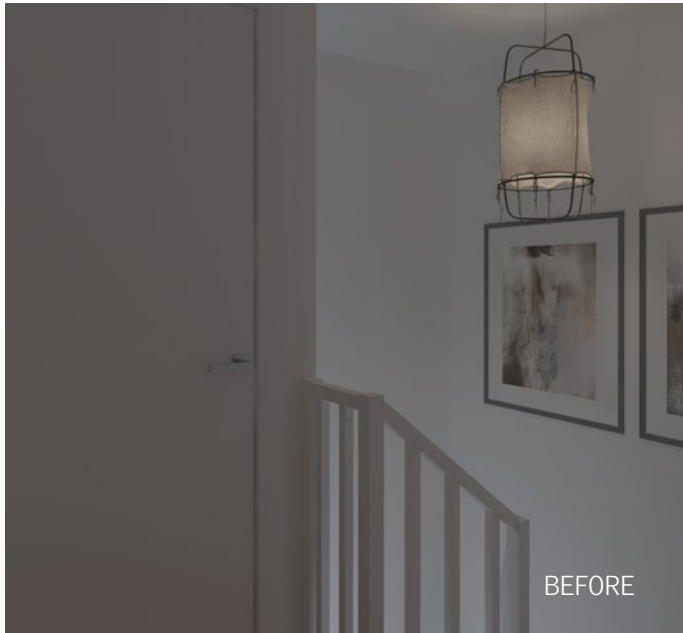

BEFORE



AFTER

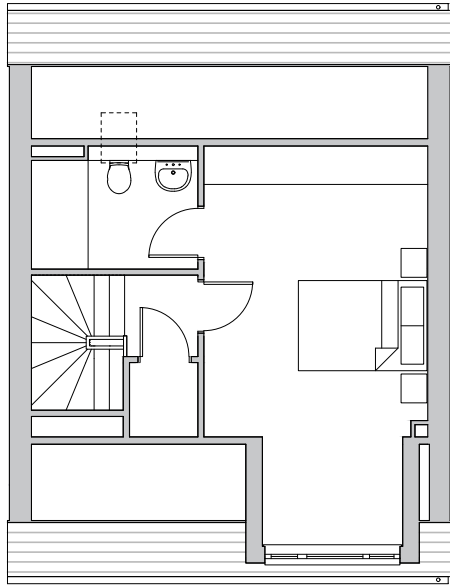

FLOOR PLAN BEFORE

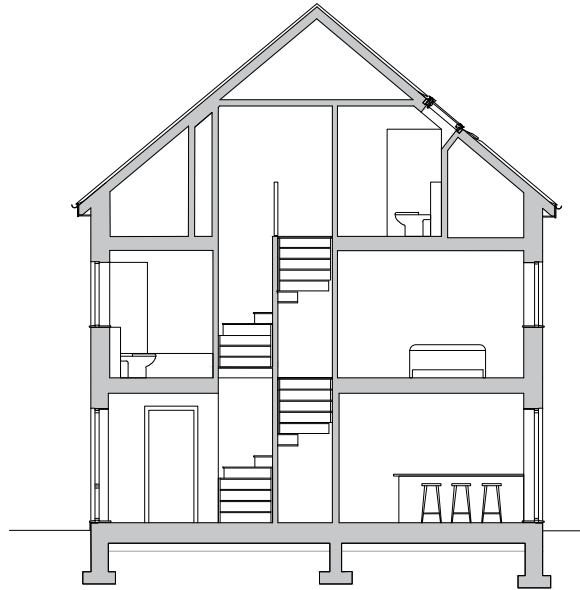

SECTION BEFORE

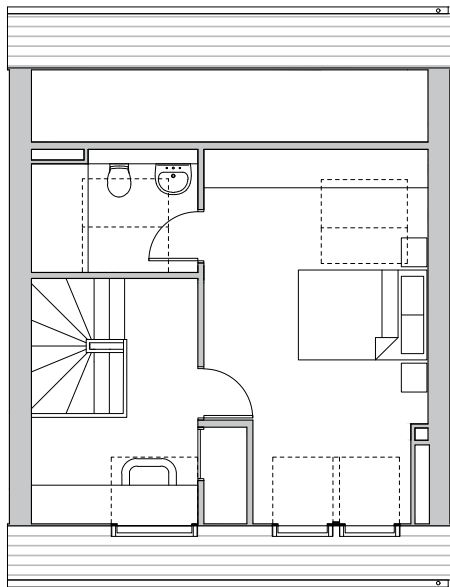

FLOOR PLAN AFTER

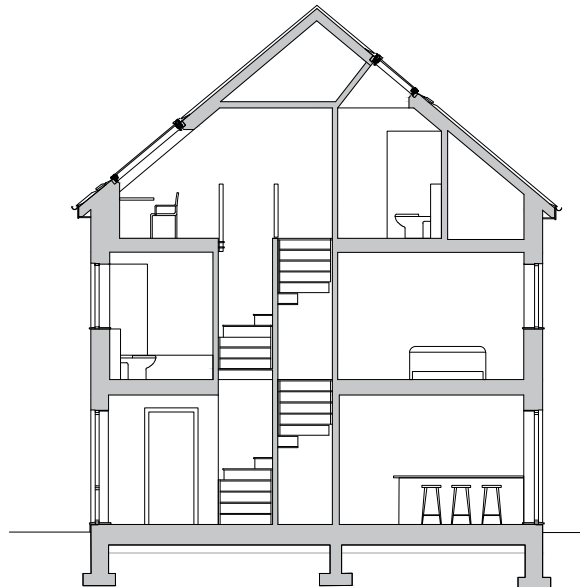

SECTION AFTER

Is your knee wall position maximising the space potential?

Often knee walls are automatically positioned at a line that meets standard head heights for marketable floor area.

This should be reconsidered. It is possible that you can incorporate an entirely new study, recreation or walk in robe space without increasing your building footprint.

Although it may not be possible to list the entire space in the advertised floor area, customers see the value. The functionality of the additional space can be a deciding factor for the home they choose and can influence how much they are willing to pay.

*Refer p.150 for more information on Daylight Analysis.







Get the colours right

The bathroom is the space where getting the right colour becomes a crucial thing, since here precision and the right nuance are important. In daylight, the colours of objects around us look natural and the human eye can distinguish slight shades of colour.

It can easily be seen when the weather changes, colours are simply more chromatic and clearer on sunny days. Having access to good natural light in bathrooms is of high value to many potential customers.







Modern & Modular

Design with roof windows has many possibilities and is well suited to both the modern aesthetic as well as modern construction methods.

Standard sizing, fast delivery and easy installation means roof windows can offer the ideal daylighting solution to off-site manufacturing or high volume on-site construction.





Let fresh air in

Many common household appliances, habits, materials and products can contribute to indoor air pollution. They can be odourless, colourless and incredibly hard to detect, made only more difficult by the fact that much of the damage they create only becomes evident over the long term. Therefore, effective ventilation and air circulation is highly important for good indoor air quality and for the health of the occupants.

On the top floor it's particularly easy to use cross ventilation efficiently, with windows placed on opposite sides of the room. Alternatively, having a combination of low and high level openings will allow a stack effect to occur.

The most efficient way to ensure good indoor air quality is to use active systems with smart sensors to monitor temperature, humidity and CO2 levels, and instruct windows to open and close automatically.





Double the daylight reach and create natural air flow

Double height combinations give an incredible 'wow' factor to any space and greatly enhance the feeling of spaciousness in the room. An otherwise small room can be transformed to feel large and generous.

Double height combinations are particularly beneficial in rooms with a deep plan, the high level windows allow light to reach to the back of the room.





SPACE TYPE

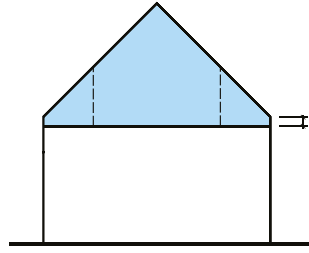
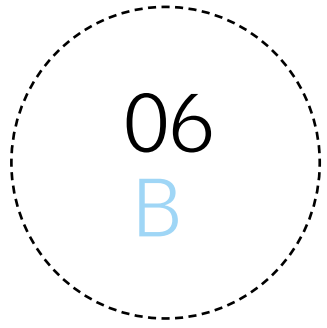

ATTIC SPACE WITH LOW/
NO PARAPET WALL







Maximise the potential - choose the right size and combination for the space

One small roof window in your attic level may meet your minimum requirements for daylight, but it misses the opportunity to transform the space into high value real estate. This can be a differentiating factor in who your potential customer decides to build their home and also in how much they are willing to pay for the space.

To increase the size of the window specified, it is usually a simple matter of cutting a rafter and installing a trimmer. Alternatively you can choose a smaller width and install 2 or 3 side by side, fitting between rafters.



AFTER





Playful spaces

Attics are very particular spaces, unconventional by the nature of their sloping walls.

It requires good planning skills, but when mastered, the resulting spaces are appealing, with unique charm.

Most often, here are placed kids' rooms and bedrooms, where we spend a lot of our time.

We need sunlight in order to feel energetic, healthy and sleep well. The indoor climate is extremely important for the occupants, and is directly linked to their health.

Respiratory problems or allergies can be caused or aggravated by poor indoor air quality.





Bonus balcony

More and more customers are looking to maximise functionality with a smaller floor area.

Younger buyers want modern features but need to start small as first time buyers. Retired buyers may want to downsize but not lose the amenity that often comes with a larger home.

An integrated balcony system reduces the cost and space required to build a traditional balcony whilst giving the connection to outdoors and amenity that customers are seeking.

It's not just the m² on paper - Customer impressions are worth more

Often knee walls are placed to start at a height that local legislation deems countable towards the overall floor area of the home.

By pushing the knee wall closer to the parapet (exterior wall) or by removing it altogether, the perception of space is much greater - meaning the square meters that are listed can often be sold at a higher price.

With no knee wall or low parapet a balcony window system can be installed. This can transform a dark, small attic space into prime real estate.





AFTER





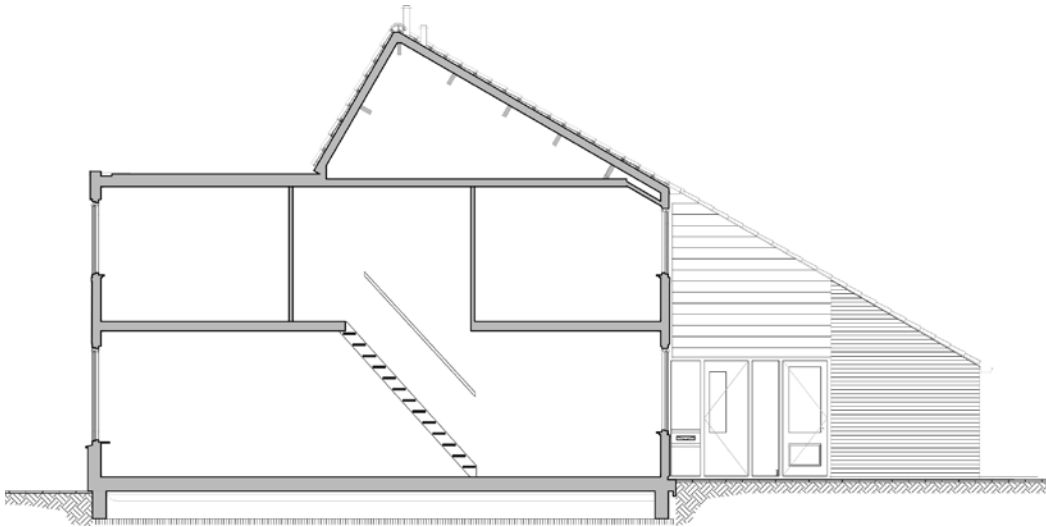

SECTION BEFORE

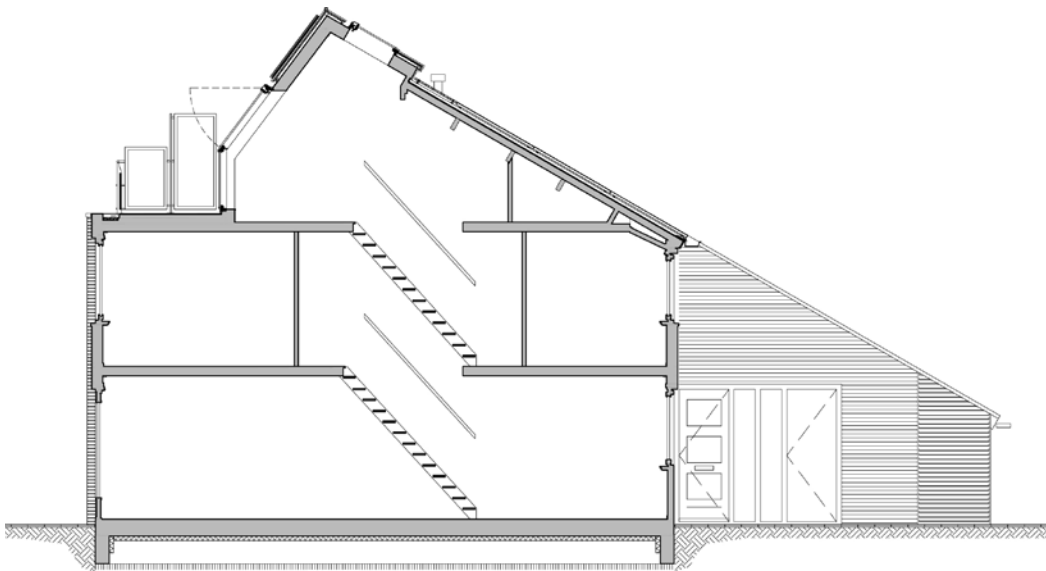

SECTION AFTER





Have you considered adding value through a roof terrace? It may be easier to integrate than you think!

It may be possible to convert your attic knee wall into an exterior wall. This can allow you to transform what was empty roof cavity into high value roof terrace.

Perhaps you have a pitched roof meeting a flat roof? In this case the adjoining flat roof can create additional property value if transformed to terrace space.



A terrace roof window system provides easy access to external space without requiring a traditional full height door. The height is instead achieved through a combination of a top hung window within the sloped roof, and a right or left hinged vertical panel below.



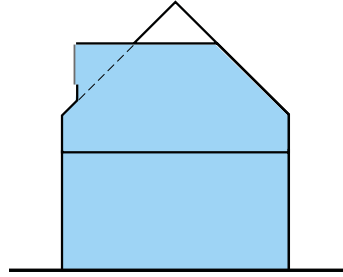
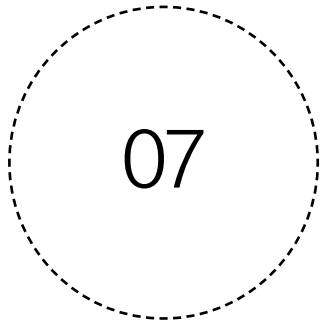

AN ATTIC SPACE
WITH A DORMER

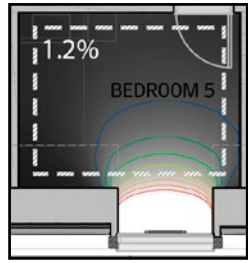

BEFORE

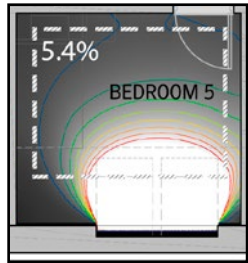

AFTER

3 x more daylight for the same glass area

Roof windows are a highly efficient tool to bring natural light into a space. They can admit up to 3 times more daylight than vertical dormer windows of the same size – distributing light evenly, saving energy and improving visual comfort levels. Roof windows have been shown to provide greater wall luminance than dormer and façade windows, resulting in less glare due to a softer transition between pane and wall.

*Refer p.150 for more information on Daylight Analysis.



AFTER



BEFORE



AFTER

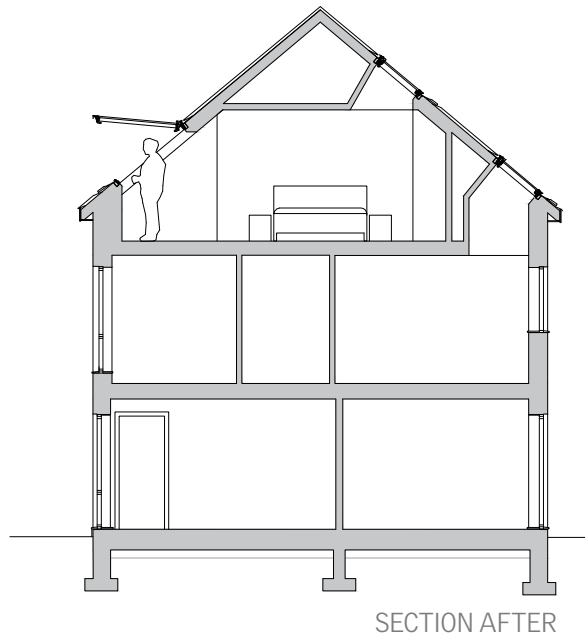
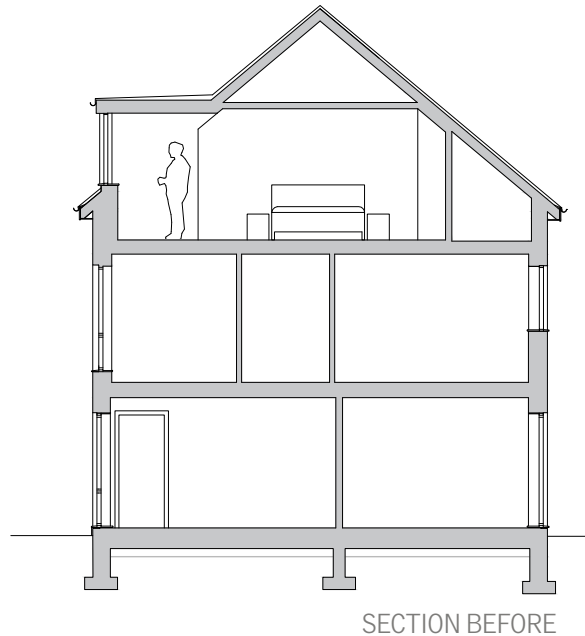

Simple economics

If you can get something that is 3 times better, at half the price, would you take it?

A roof window can bring in up to 3 times more daylight than a dormer with the same size of glazing area.

It requires smaller consumption of materials, which means it's not as heavy and it's much cheaper than a dormer. Installing roof windows is fast and easy, and it's not necessary to have some special tools.

Roof windows are much more energy efficient, as dormers have a significantly bigger exterior area and thus lose more heat.

When designed correctly, a loft with roof windows will have sufficient head height and a higher value per square meter.



AFTER

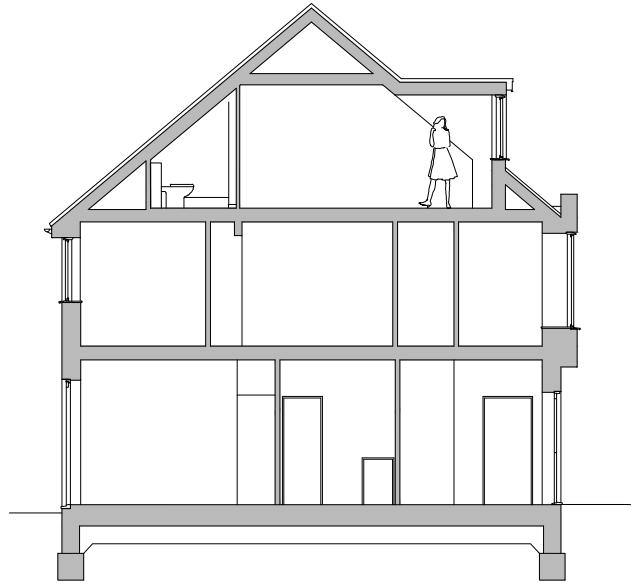

SECTION BEFORE

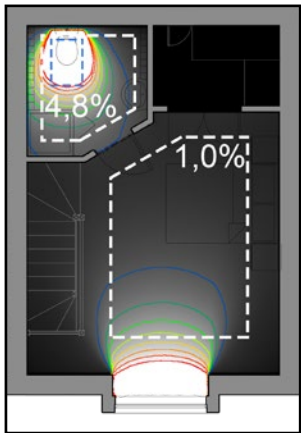

BEFORE

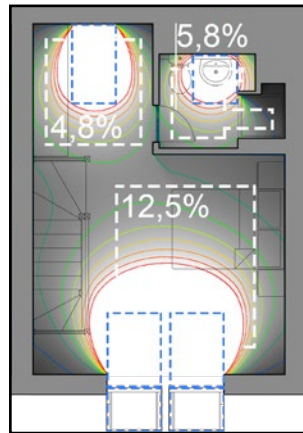

AFTER

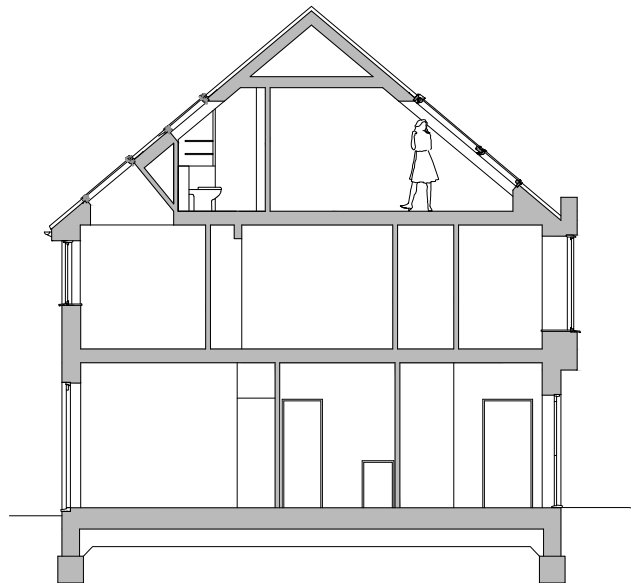

SECTION AFTER

The health benefits of daylight in the home

Sunlight is an environmental indicator that helps set the body's circadian rhythm (sleep-wake cycle). It helps the brain learn when it's time to produce melatonin for us to fall asleep and acetylcholine for when it's time to wake up.

Ventilation is also extremely important for a good sleep. The extra oxygen that comes with fresh air results in higher brain functioning, enhanced concentration skills, and more energy.

Natural lighting and ventilation are ideal for both health and energy bill.

*Refer p.150 for more information on Daylight Analysis



AFTER



Optimise space and increase flexibility in your floor plans

By understanding the details of the height clearances required for ergonomic movements the floor plan can be optimised.

In bathrooms, the sloped roof space is best utilised by vanity basins and WC's. Often a roof window solution will both increase the flexibility in the layout as well as provide better ventilation, daylight and privacy.

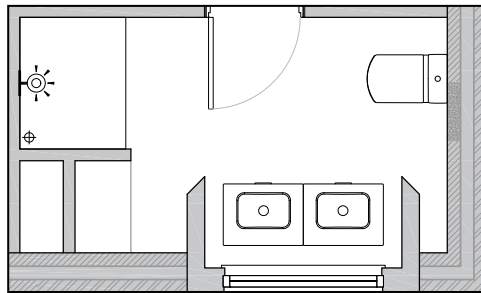

FLOOR PLAN
BEFORE

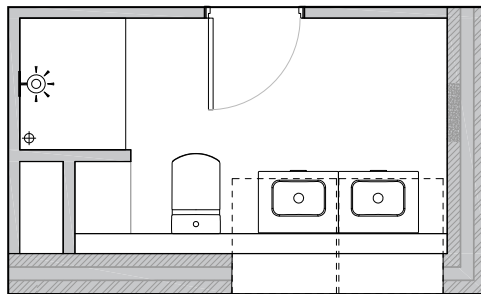

FLOOR PLAN
AFTER









Get the lining right to maximise the daylight and views

The lining is of great importance to the performance and overall impression of the roof window within any space.

Splayed linings not only improve the daylight reach, they also create an inviting opening that ensures the entire view from the window can be enjoyed.



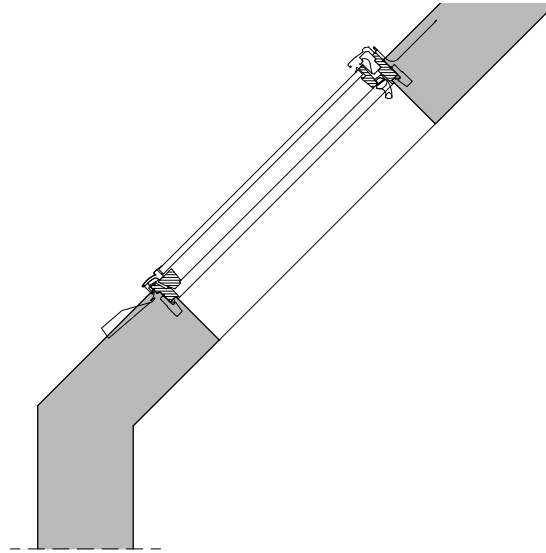

SECTIONAL DETAIL
SUB-OPTIMAL LINING

With optimal lining details you can increase the daylight that reaches your attic's interior surfaces by more than 20%*

For in reach applications, the top lining should be horizontal and the bottom vertical to allow the maximum amount of daylight into the room.

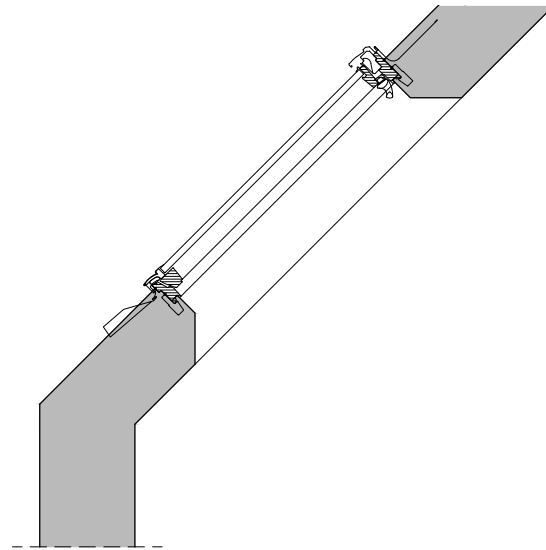

SECTIONAL DETAIL
RECOMMENDED LINING

Top and bottom linings at right angles to the window should be avoided. Not only does this impair views and light, it can also result in cold areas at the bottom of the window, allowing condensation to occur.

Note that the colour of the lining also has an influence on the amount of light reflected into the room - the lighter the colour, the more daylight is reflected.

*Source: VELUX A/S (Jun. 2013) - Impact of lining design on daylight conditions in simple rooms.



Photographer: Patricia Weisskirchner
Builder: Magnum Haus



For out-of-reach applications, no matter what the roof pitch, it is recommended to have a minimum 45° splay to the top and bottom of the lining.

For flat roof windows it is also optimal to have a splay to all sides of the lining. Where this is not possible it is best to splay the edges that direct the light deeper into the floor plan.

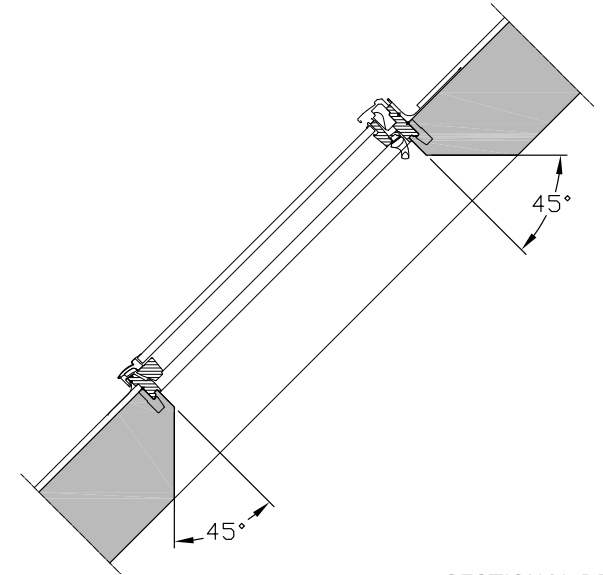

SECTIONAL DETAIL
RECOMMENDED LINING





Get creative with integration

Linings can also be incorporated into window sills that act as shelving, built-in seats or daybeds. This is a great way to create a standout feature in a room and differentiate your spaces from competitors.

MEASURING DAYLIGHT

IV

Daylight Factor

There are multiple metrics and parameters that can be used to quantify the amount of daylight in a planned or existing space. In this Design Booklet the daylight conditions are described using Daylight Factor (DF). DF is a simple metric that is useful from the initial design stages of a project. It does not require knowledge of the building orientation and can be used as an effective design tool to compare daylight conditions for different initial design scenarios.

DF is a widely recognisable metric that is part of a building code in many countries and is the primary metric applied in Daylight Standard EN17037. The DF is a ratio between internal and external illuminance in lux. In simple words, it informs us how much daylight from the outside is reaching inside the building on a cloudy day. Most commonly, an average value of daylight factor from a grid of points is given to describe the daylight potential of space. The grid of points should be set at a height of a typical work plane (usually around 85 cm).

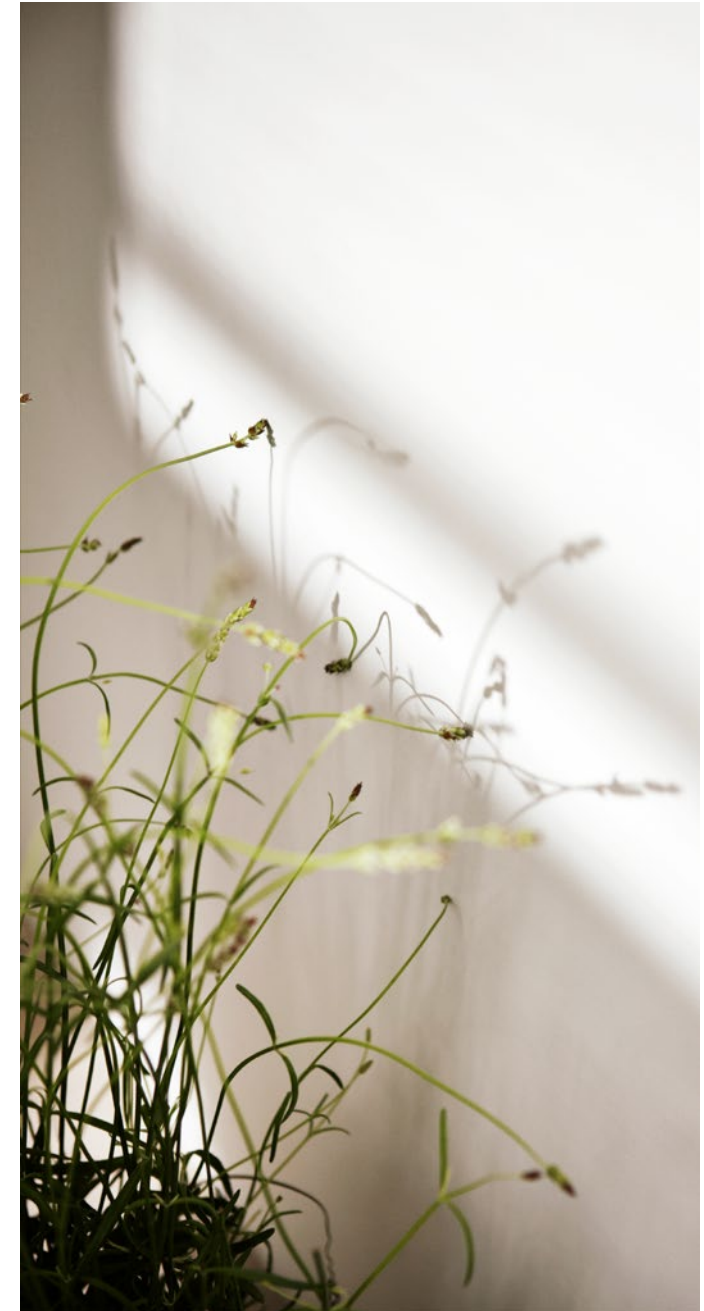

What should you aim for?

Rooms with an average DF of 2% or more can be considered daylit, but electric lighting will still be needed to perform visual tasks. With an average DF of 5% or more electric lighting will most likely not be used during daylight hours.

Besides achieving optimal daylight levels in a room, it is also important to provide an even distribution of daylight.

It often happens, especially for deep rooms, that there are high levels of daylight close to the window, whilst the rear areas of the room are dark.

High levels of such contrast may cause visual discomfort and artificial light is likely to be used to compensate. Daylight through the roof can help to solve a problem of uneven distribution of daylight.

To create your own daylight analysis use the QR code provided and download free simulation software.

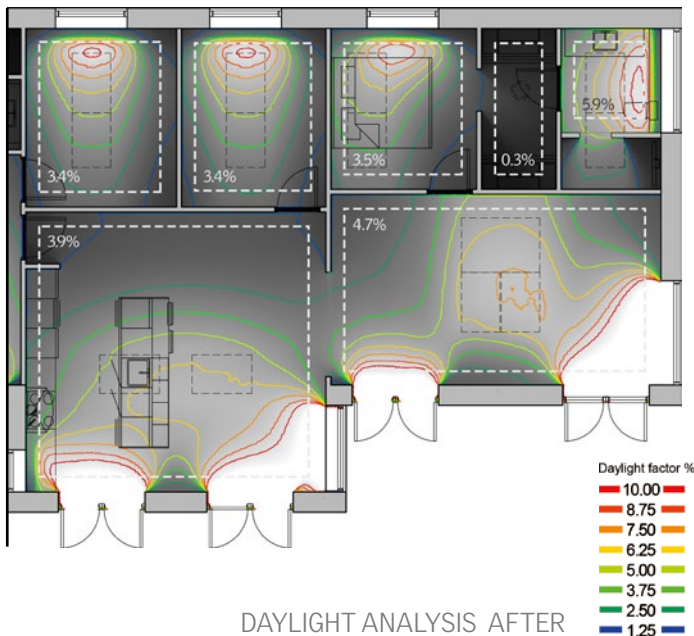
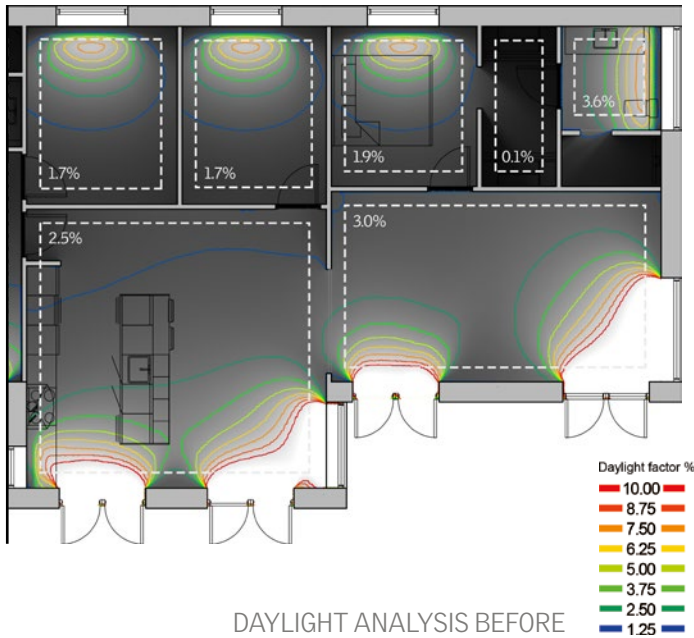

V



TYPE, SIZE & PLACEMENT

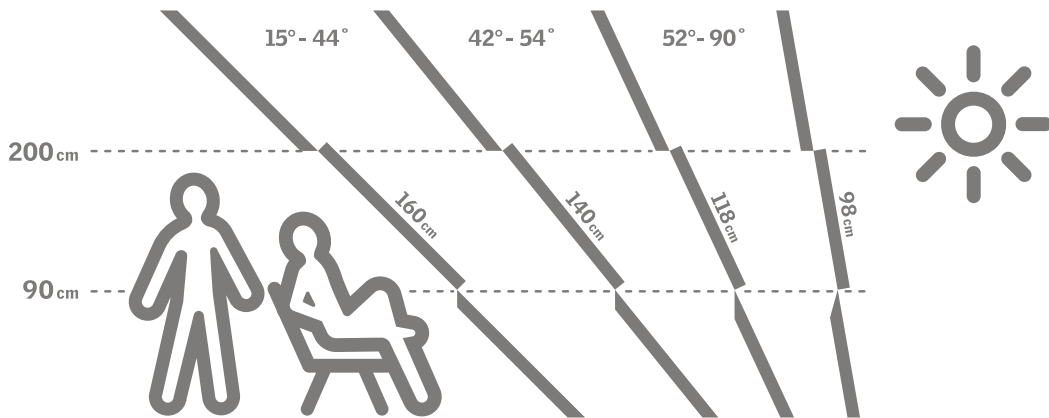
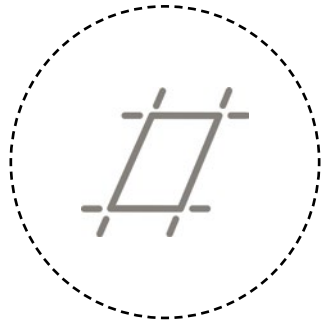

Guidelines

For roof windows placed within reach, try to allow for a clear view when standing and when seated. Note that the optimum window height depends on the roof pitch.



Top operated roof windows make it possible to place furniture directly below the window without obstructing operation of the window.



Bottom operated roof windows make it possible to stand upright under the open window while looking out to the sides, providing extra headroom and maximising the feeling of extra space. These windows are also suitable for emergency escape/access purposes.



If the roof window is placed out of reach, consider electrical operation, which makes it possible to operate the window as well as interior and exterior sunscreening products from a control pad or digital app.

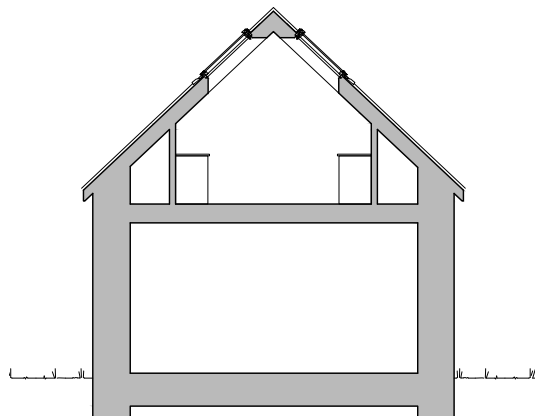

SECTION BEFORE

Often roof windows are placed in high out of reach positions as a default. In many cases this is not optimal as views to the outside are reduced and surfaces against the wall are more likely left in shadow.

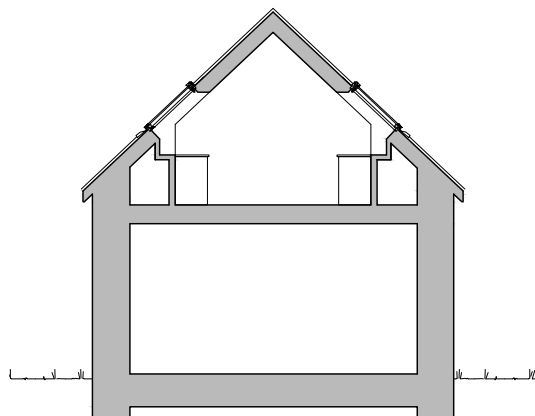

SECTION AFTER

In an attic level kitchen space, it is ideal to incorporate in-reach, roof windows or a double height combination. This allows not only better light conditions to the bench top, it ensures views to the outside and also allows for easy operation for ventilation whilst cooking.



KITCHEN & DINING

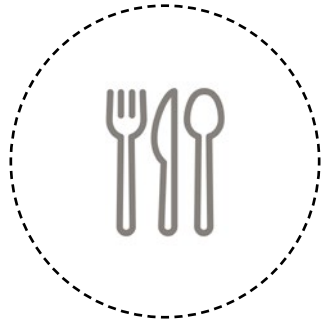

Guidelines

Incorporating the right combination of roof windows into your attic level kitchen design will give balanced daylight, as well as efficient, practical ventilation. This will have a greater impact on your customer than expensive countertops or cupboard fronts.

Top operated windows make it possible to have a continuous, well-lit worktop directly below the window without obstructing operation of the window.

A double height combination of roof windows offers a great solution to bring daylight deeper into the floor plan. This should be considered if you have a high activity surface such as a kitchen island bench located central to the floor plan away from other windows.

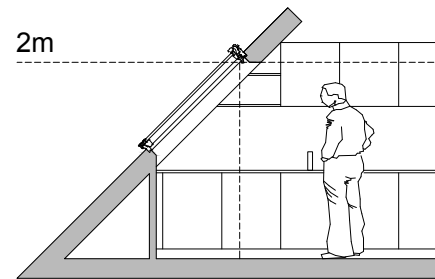
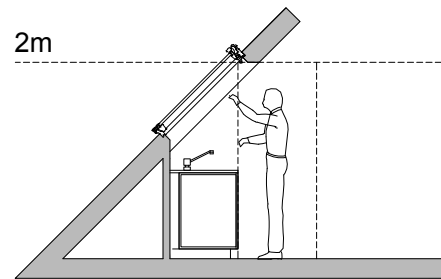
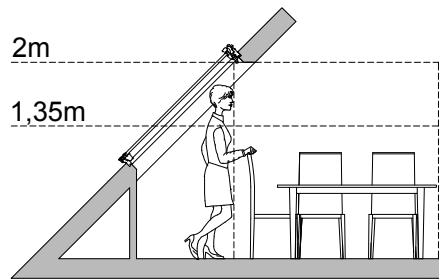

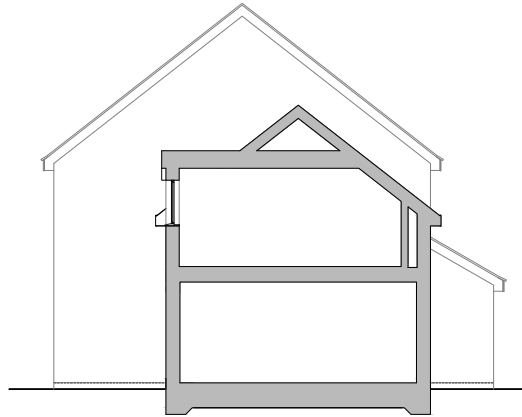

SECTION BEFORE

Low head height spaces in bedroom or near stair landings are often left unresolved and are filled with unusable, expensive dormer space, knee walls or deep cupboards.

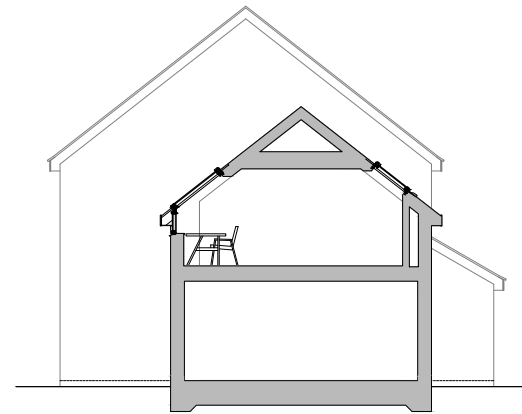

SECTION AFTER

Study spaces can fit in low head height areas under the roof slope and are perfect for bright locations under roof windows. By reducing knee walls or replacing dormers with new study space you can create extremely practical and valued space for your customers.





Guidelines

Do you have an under-utilised landing or wasted cupboard space on your attic level? It can be surprising where you can fit a useful and light filled study space.

Centre-pivot windows make it possible to have a desk placed directly below the window without obstructing operation of the window. Use the low height spaces to place furniture and make sure there is walking height next to it.

Studies have found that improved air quality can boost task solving performance by up to 15%, while daylight can improve how quickly children learn and retain information by up to 18% and increase productivity with up to 15%.*

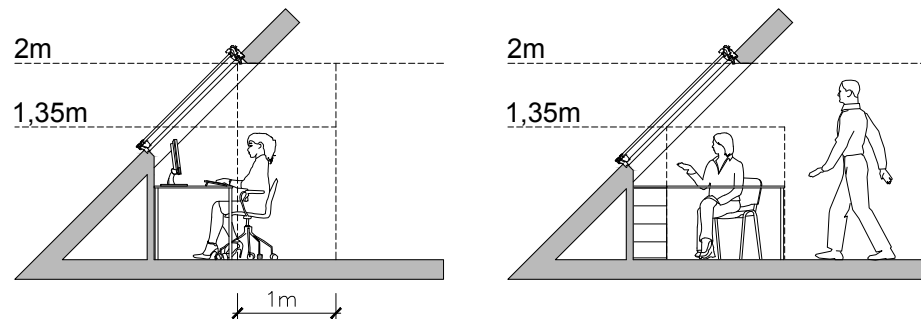

*Sources: Heschong (2002) - Daylighting and Human Performance.

Barrett, Zhang, Davies and Barrett (2015)-Clever classrooms: Summary report of the HEAD project.

Edwards, Torcellini (2002) - A Literature Review of the Effects of Natural Light on Building Occupants.

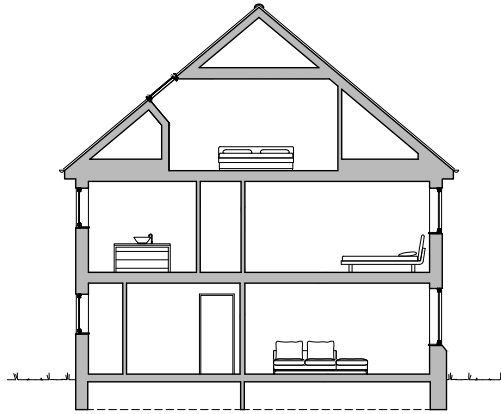

SECTION BEFORE

In attic level bedroom spaces often the lower head height area is entirely blocked by a high knee wall or limited to cupboards. It is also common for roof windows to be placed only in out-of-reach positions, restricting a more interesting and valued view to the outside.

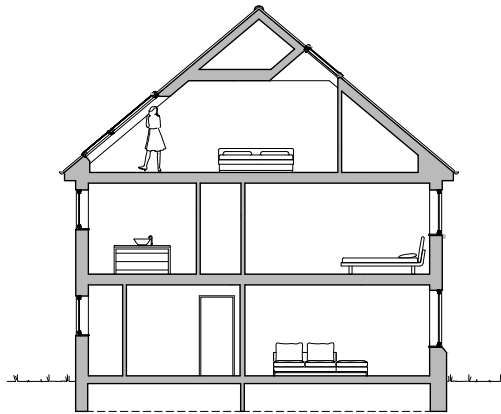

SECTION AFTER

The space under the slopes can be easily used to create a relaxation area with a cosy armchair, sofa or bed. It can also be valuable area for increasing walk in robe space, where desk-height drawers or cupboards with a roof window above can create a practical light filled dressing area.



BEFORE



AFTER

LIVING &
SLEEPING



Guidelines

Placing roof windows above the bed is a simple way to bring in the star-studded night sky and completely transform the room. A well placed roof window in a small bedroom will fill it with ample natural light, whilst adding a visual touch of treetops and sky to create a sense of spaciousness.

Consider removing the unnecessary knee walls to increase the floor area. The lower sub-slopes are great storage, play, seating and decoration spaces and can also enlarge the view to the outside. Even if the space cannot be counted towards the advertised size of the room the impression on the potential buyer can influence their choice to purchase as well as how much they are willing to pay.

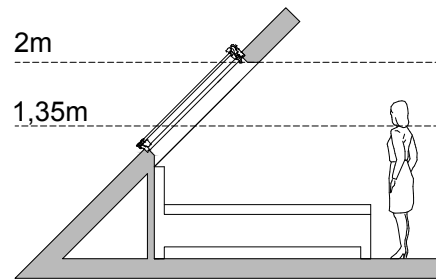
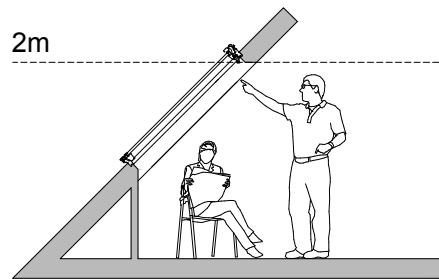
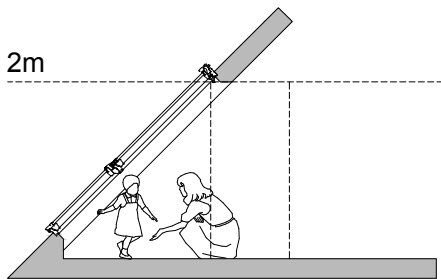

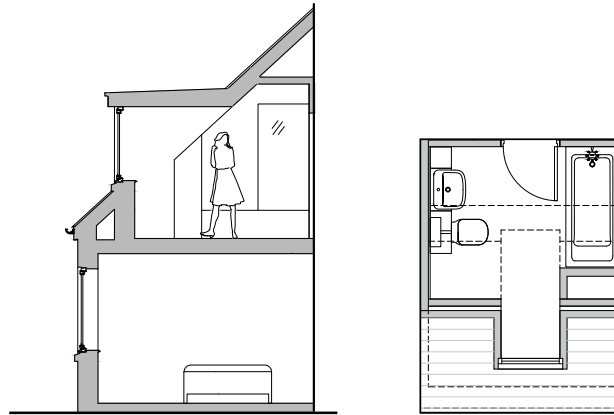

SECTION & PLAN BEFORE

Dormers are often used to gain additional head height when a layout suitable to the attic space seems difficult to achieve. Often the expensive 'additional' space is impractical & under utilised.



BEFORE

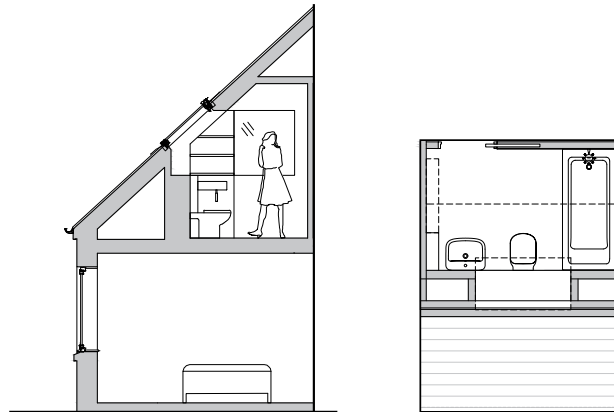

SECTION & PLAN AFTER

By using the required heights for ergonomic movement it is possible to maximise the use of space under a sloped roof, particularly with strategically placed roof windows to create additional head height where needed.



AFTER

BATHROOM



Guidelines

When possible, place basins, baths and WCs against the parapet or knee wall to maximise space under sloped roof. By adding a roof window over, with optimal linings, you can increase head height by approximately 200mm depending on the depth of your roof construction.

A strategically sized roof window can offer daylight along with easily controlled ventilation whilst maintaining privacy - something often unachievable with traditional facade windows.

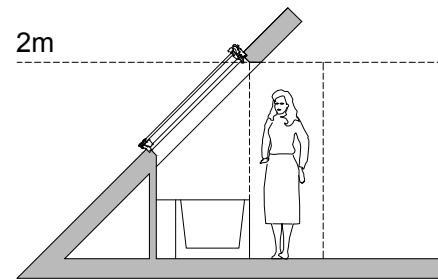
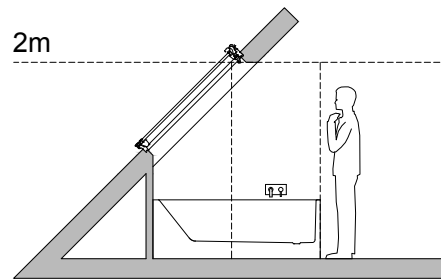
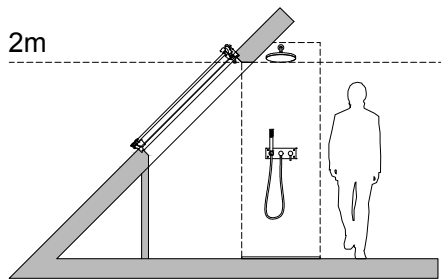
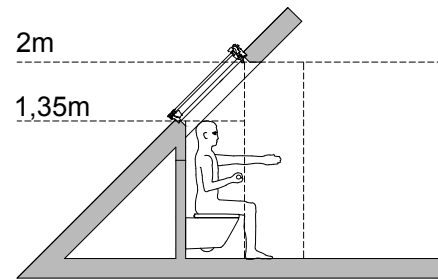
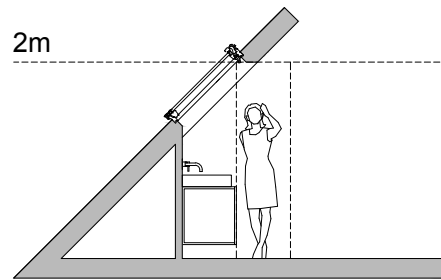
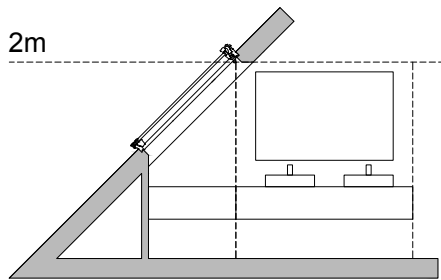



ReThink
Daylight

